

# retigo®

PERFECTION IN COOKING AND MORE...

## Blast chiller / freezer **Combi-chill**

**OPERATING MANUAL**



 **READ THIS MANUAL BEFORE USE**

## 1. INDEX

1. INDEX.....	1
2. ANALYTICAL INDEX.....	2
3. SAFETY.....	3
4. REGULATIONS AND GENERAL INSTRUCTIONS.....	4
4.1. General information.....	4
4.2. Warranty.....	4
4.3. Replacement of Parts.....	4
4.4. Description of the Appliance.....	5
4.5. Features Plate.....	6
4.6. Safety Devices.....	7
5. USE AND FUNCTIONING.....	8
5.1. First Switching.....	8
5.2. Blast chiller mode.....	8
5.3. Special Cycles Mode.....	20
5.4. Recipes Mode.....	31
5.5. Pre-cooling.....	35
5.6. Settings.....	36
5.7. Use of the USB port.....	37
5.8. Recommendations for Use.....	38
6. CLEANING AND MAINTENANCE.....	39
6.1. Recommendations for Cleaning and Maintenance.....	39
6.2. Routine Maintenance.....	39
6.3. Extraordinary Maintenance (5T Version).....	40
6.4. Extraordinary Maintenance (TABLE Version).....	42
7. TROUBLESHOOTING.....	44
7.1. Faults Display.....	45
8. INSTALLATION.....	47
8.1. Packaging And Unpacking.....	47
8.2. Installation.....	47
8.3. Electric Power Supply Connection.....	48
8.4. Condensing unit water connection.....	48
8.5. Inspection.....	49
9. DISPOSAL OF THE APPLIANCE.....	50
10.REFRIGERANT TECHNICAL CARD.....	50
ATTACHMENTS.....	I

**2. ANALYTICAL INDEX****B**

Blast chiller mode; 8  
 Blast Chilling Recipes; 32

**C**

Cleaning the condenser; 40; 43  
 Cleaning the evaporator; 40; 42  
 Condensing unit water connection; 48  
 Continuous Temperature Cycle; 18  
 Continuous Timed Cycle; 17  
 Custom Cycle; 19

**D**

Defrosting Cycle; 22  
 Description of the Appliance; 5  
 Disposal of the Appliance; 50  
 Door micro switch; 7  
 Download and Upload of recipes; 37  
 Download and Upload Parameters; 37  
 Download HACCP records; 37  
 Drying Cycle; 22

**E**

Electric Power Supply Connection; 48  
 Evaporator Fan Micro switch; 7  
 Extraordinary Maintenance (5T Version); 40  
 Extraordinary Maintenance (TABLE Version); 42

**F**

Faults Display; 45  
 Features Plate; 6  
 First Switching; 8  
 Fish Sanitization Cycle; 21  
 Frosting recipes; 33

**G**

General information; 4

**H**

Heating Cycle Product Probe; 24  
 High condensation temperature alarm; 7

**I**

Ice Cream Hardening Cycle; 23  
 Inspection; 49  
 Installation; 47

**L**

Language Selection; 36

**P**

Packaging; 47  
 Positive Temperature Blast Chilling; 9  
 Pre-cooling; 35  
 Prolonged Inactivity; 38  
 Protective Fuses; 7  
 Proving Cycle (Optional); 25

**R**

Recipes Mode; 31  
 Recommendations for Cleaning and Maintenance;  
 39  
 Recommendations for normal use; 38  
 Recommendations for Use; 38  
 REFRIGERANT TECHNICAL CARD; 50  
 Replacement of Parts; 4  
 Replacing the fuses; 41; 42  
 Routine Maintenance; 39

**S**

SAFETY; 3  
 Safety Devices; 7  
 Service; 36  
 Settings; 36  
 Setup; 36  
 Special Cycles Mode; 20  
 Sterilization Cycle; 23  
 Store a recipe; 34

**T**

Temperature Frosting Cycle; 13  
 Temperature Slow Cooking Cycle; 27  
 Thawing Cycle (Optional); 24  
 Time Positive Blast Chilling Cycle; 11  
 Timed Frosting Cycle; 15  
 Timed Slow Cooking Cycle; 29



**U**

U.V. Lamp Replacement; 41; 43  
 Unpacking; 47  
 Use of the USB port; 37

**W**

Warranty; 4

### 3. SAFETY

  It is recommended to carefully read the instructions and warnings contained in this manual before using the appliance. The information contained in the manual is fundamental for the safety of use and for machine maintenance.

 Keep this manual carefully so that it can be consulted when necessary.

 The electric plant has been designed in compliance with the IEC EN 60335-2-89 Standard.

 Maintain ventilation openings in the appliance casing or in the built-in structure free from all obstructions.

 Do not use mechanical devices or other means to accelerate the defrosting process, other than those recommended by the manufacturer.

 Do not damage the coolant circuit.

 Do not use electrical appliances inside the appliance compartments for storage of frozen food.

 Do not store explosives, such as pressurised containers with flammable propellant, in this unit.

 Do not place anything on the bottom of the device. Use the appropriate racks to store the product.

 The maximum permissible load for the racks is 45kg evenly distributed.

 if the supply cord is damaged, it must be replaced by the manufacturer, its service agent or similarly qualified persons in order to avoid hazard.

 Specific adhesives highlight the presence of mains voltage in the proximity of areas (however protected) with risks of an electrical nature.

 If a stationary appliance is not fitted with a supply cord and a plug, the means for disconnection must be incorporated in the fixed wiring in accordance with the wiring rules.

In the design and construction phase, the manufacturer has paid particular attention to the aspects that can cause risks to safety and health of persons that interact with the appliance.

Carefully read the instructions stated in the manual and those applied directly to the machine, and particularly respect those regarding safety.

Do not tamper with, evade, eliminate or by-pass the installed safety devices. Failure to comply with this requisite can lead to serious risks for personal health and safety.

It is recommended to simulate some test manoeuvres to identify the controls, in particular those relative to switch-on and switch-off and their main functions.

The appliance is only destined for the use for which it has been designed; any other use must be considered improper.

The manufacturer declines all liability for any damage to objects or injury to persons owing to improper or incorrect use.

 All maintenance interventions that require precise technical skill or particular ability must be performed exclusively by qualified staff.

 When using the appliance, never obstruct the air inlet when the appliance is on, so as not to compromise its performance and safety.

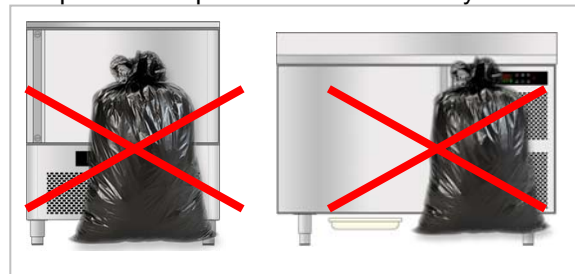

 Never stretch the power cable.

In order to guarantee hygiene and protect the foodstuffs from contamination, the elements that come into direct or indirect contact with the

foodstuffs must be cleaned very well along with the surrounding areas. These operations must only be performed using detergents that can be used with foodstuffs, avoiding inflammable products or those that contain substances that are harmful to personal health.

In the case of prolonged inactivity, as well as disconnecting all the supply lines, it is necessary to accurately clean all internal and external parts of the appliance.

## 4. REGULATIONS AND GENERAL INSTRUCTIONS

### 4.1. General information

This manual has been designed by the manufacturer to provide the necessary information to those who are authorised to interact with the appliance.

The persons receiving the information must read it carefully and apply it strictly. Reading the information contained in this document will allow the user to prevent risks to personal health and safety.

Keep this manual for the entire operating life of the equipment in a place which is well-known and easily accessible, so that it is always available when its consultation becomes necessary.

Particular symbols have been used to highlight some parts of the text that are very important or to indicate some important specifications. Their meanings are given below:



**Indicates important information regarding safety. Behave appropriately so as not to risk the health and safety of persons or cause damage.**



**Indicates particularly important technical information that must not be ignored.**

### 4.2. Warranty

The warranty of the equipment and the components we produce has duration of 2 (two) years from the date of delivery and translates into the supply, free of charge, of parts that we consider to be faulty.

These faults must, however, be independent from incorrect use of the product in compliance with the indications stated in the manual.

Fees deriving from labour, journeys and transport are excluded from the warranty.

The materials replaced under warranty are our property and must therefore be returned under the responsibility and expense of the customer.

### 4.3. Replacement of Parts



Activate all envisioned safety devices before carrying out any replacement intervention.



In particular, deactivate the electrical power supply using the differential isolating switch. Only use original spare parts to replace worn components.



All responsibility is declined for injury to persons or damage to components deriving from the use of non-original spare parts and interventions which could modify the safety requisites, without authorisation of the manufacturer.

## 4.4. Description of the Appliance

### 5T version

The Blast chiller-Shock freezer, from now on defined as appliance, has been designed and built to cool and/or freeze foodstuffs in the professional catering ambit.

- 1) **condensation area:** it is positioned in the lower part and is characterised by the presence of the condensing unit.
- 2) **electric area:** it is positioned in the lower part of the appliance and contains the control and power supply components as well as electric wiring.
- 3) **evaporation area:** it is situated inside the refrigerated compartment in the rear and is characterised by the evaporating unit.
- 4) **storage area:** it is situated inside the refrigerated compartment and is destined for the cooling and/or freezing of foodstuffs.

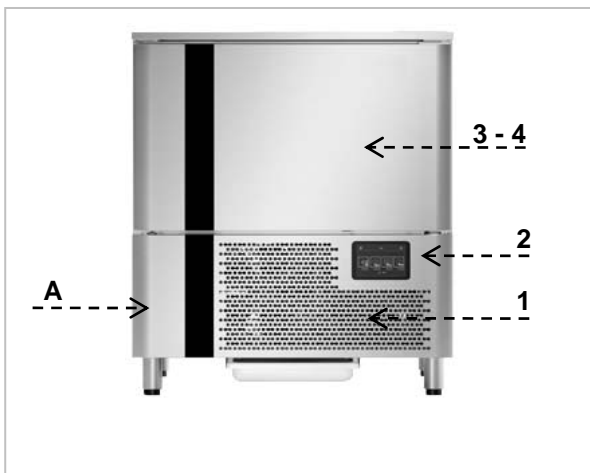

The lower part is also distinguished by a control panel (A) that allows access to the electric parts; there is a vertically-opening door in the front, which closes the refrigerated compartment hermetically.

Depending on requirements, the appliance is produced in several versions.

### 5 TRAY BLAST CHILLER and SHOCK FREEZER

Model suitable to contain 5 trays with blast chilling capacity of 20 kg and 12 kg in shock freezing.

### TABLE version

The Blast chiller-Shock freezer, from now on defined as appliance, has been designed and built to cool and/or freeze foodstuffs in the professional catering ambit.

- 5) **condensation area:** it is positioned in the lateral part and is characterised by the presence of the condensing unit.
- 6) **electric area:** it is positioned in the lateral part of the appliance and contains the control and power supply appliance as well as electric wiring.
- 7) **evaporation area:** it is situated inside the refrigerated compartment in the rear and is characterised by the evaporating unit.
- 8) **storage area:** it is situated inside the refrigerated compartment and is destined for the cooling and/or freezing of foodstuffs.

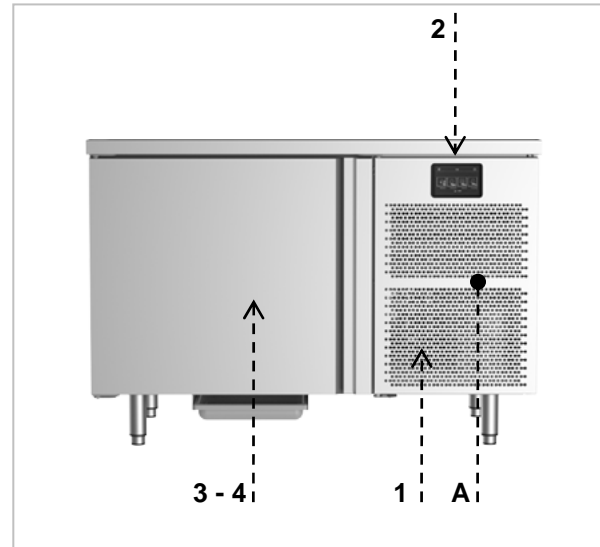

The lateral part is also distinguished by a control panel (A) that allows access to the electric parts; there is a vertically-opening door in the front, which closes the refrigerated compartment hermetically.

Depending on requirements, the appliance is produced in several versions.

### GASTRONOMY BLAST CHILLER

Model suitable to contain 5 GASTRONORM 1/1 trays with blast chilling capacity of 20 kg and 12 kg in shock freezing.



### CONFECTIONERY BLAST CHILLER

Model suitable to contain 5 CONFECTIONERY 400x600 trays with blast chilling capacity of 20 kg and 12 kg in shock freezing.

## 4.5. Features Plate

The identification plate shown is applied directly onto the appliance. It states the references and all indications indispensable for working in safety.

- 1) Appliance code
- 2) Description of the appliance
- 3) Serial number
- 4) Power supply voltage and frequency
- 5) Rated output
- 6) Defrosting output
- 7) Total light output
- 8) Climatic class
- 9) Type and Amount of refrigerant gas
- 10) WEEE symbol

CODE /KODE CODICE		1
MODEL / MODELL MODELLO		2
SERIAL No/SERIEN NR. MATRICOLA		3
TENSION/SPANNUNG TENSIONE		4
INPUT LEISTUNGS-AUFNABME POTENZA		5
		6
		7
CLIMATIC CLASS KLIMAKLASSE CLASSE CLIMATICA		8
REFRIGERANT KUEHLMITTEL REFRIGERANTE		9
		10

The appliances are equipped with climatic class that indicates the room temperature within which the refrigerator is operating correctly. The following climatic classes exist:

Climatic Class	Room Temperature °C	Related Humidity %
0	20	50
1	16	80
2	22	65
3	25	60
4	30	55
6	27	70
5	40	40
7	35	75

## 4.6. Safety Devices

During the running of appliance, some control devices may activate and govern the correct running of the machine. In other cases, they may deactivate parts or the whole machine, to put the appliance in safe conditions. Main controls are described below.

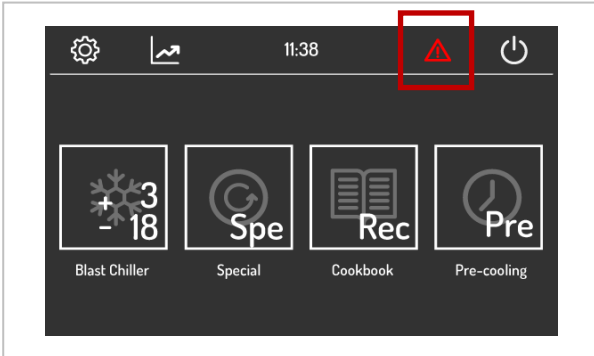

### Door micro switch

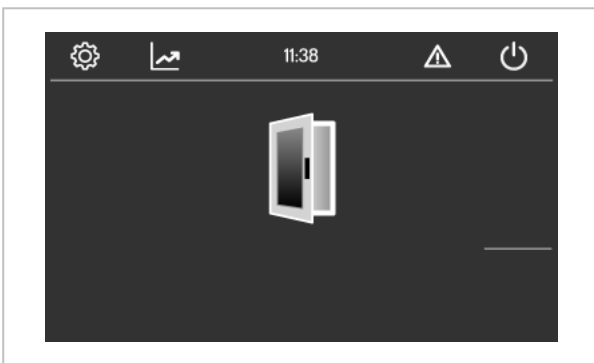

If the door is opened, the magnetic switch placed on the control board opens and, during blast-chilling or shock-freezing, evaporator fans go off and a warning message appears on the display at the same time. This condition may also be determined when the door is not perfectly aligned to or near the control board: in this case with machine in **STOP** phase, cycle start-up is prevented, apart from start-up of the defrosting cycle.

*If a U.V. sterilisation cycle is active, the functioning of the U.V. lamp is interrupted. The cycle continues when the door is closed.*

### Protective Fuses

Some protection fuses in the general power supply line are activated in case of overload.

### High condensation temperature alarm

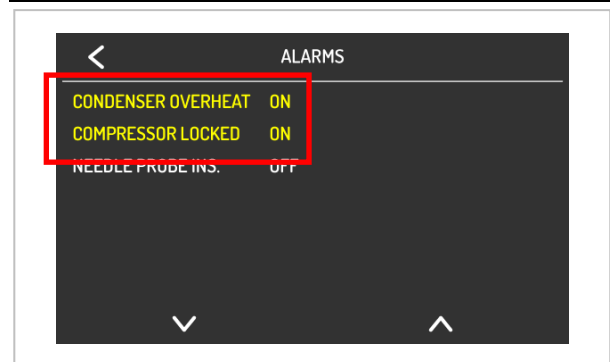

In the event of room conditions or functional failures, which cause the condenser to exceed the maximum temperature value, an alarm is triggered and stops the machine running. The machine can be run when an acceptable temperature value is reset.

### Evaporator Fan Micro switch

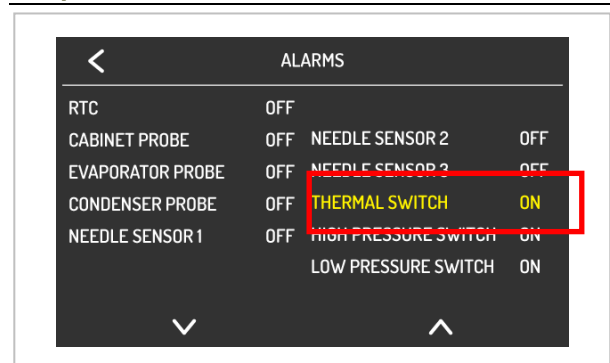

If the deflector is opened to inspect the evaporator or fans, this micro switch positioned on the evaporator deflector, deactivates machine functioning. Closure of the deflector with the successive disappearance of the alarm on the display, restores normal machine functioning.

GB



## 5. USE AND FUNCTIONING

### 5.1. First Switching

At the first switching of the machine, the device displays the ON / Standby screen.

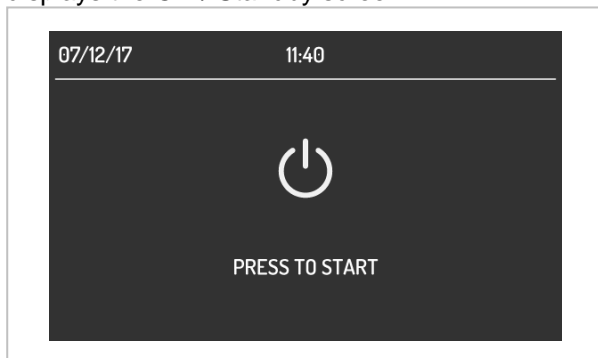

To turn the device on, from the ON/Stand-by screen, press the central area to show the Home screen.

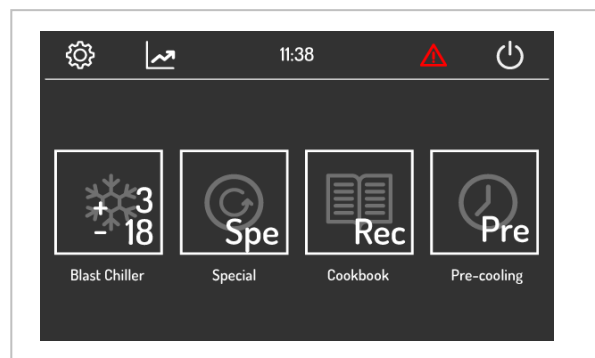

From the Home screen it is possible to enter the functioning mode of the machine simply selecting the area.

To switch the device off, press the area  on top of the Home screen.

### 5.2. Blast chiller mode



By selecting the area  you will enter the BLAST CHILLER menu. Proceed by selecting one of the available areas at choice:

- Blast chilling
- Shock freezing
- Continuous cycle
- Custom cycle.

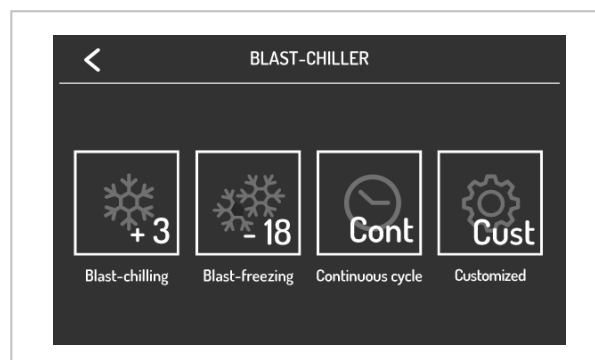





### Positive Temperature Blast Chilling

**i** This cycle lowers the temperature at the core of the product from **+ 90 ° C** to **+ 3 ° C** in the shortest time possible and within a maximum time of **90 minutes**. The end of the cycle is determined by the achievement of the value **+ 3 ° C** read by the core probe.

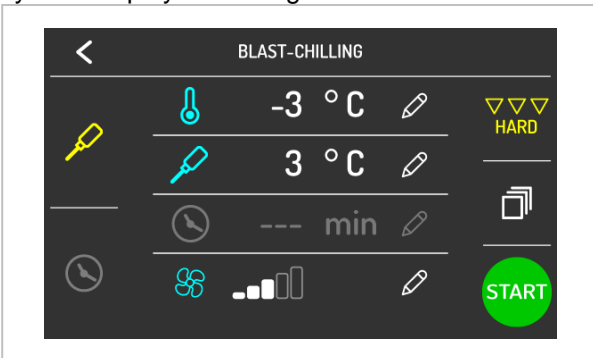

Selecting the positive blast chilling cycle, the system displays following screenshot :

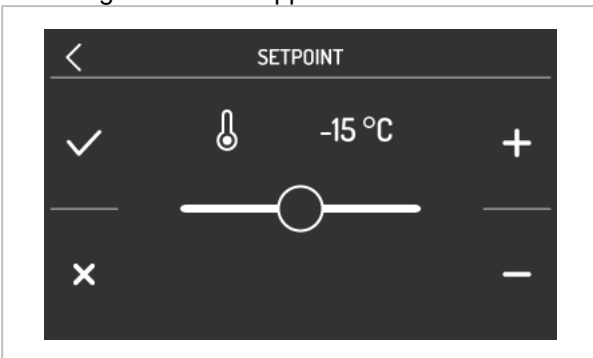

By default the system suggests the temperature cycle.

Pressing the area  it is possible to change the operating cell temperature. Following screenshot appears :



By pressing the  and  area the temperature value can be changed.

To confirm the new value, press the  area;

To cancel the change press the area .

To exit without saving press the area .

Pressing the area  it is possible to change the product temperature at the end of the cycle.

Pressing the area  it is possible to change the fan speed during the blast chilling.



Pressing the area  it is possible to change the cell temperature and the speed of the fans during the conservation phase :

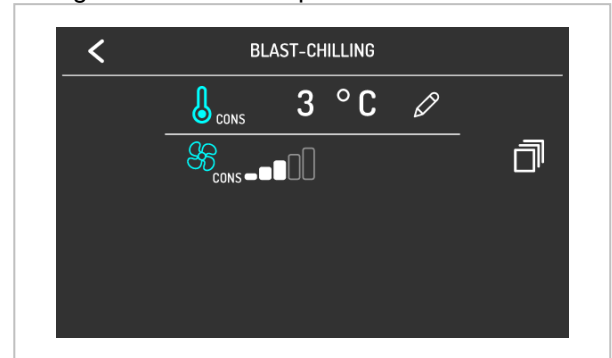

Press the area  to enable the intensive phase: the relative area will be enlightened





In this case the positive chilling cycle will be divided into three stages :

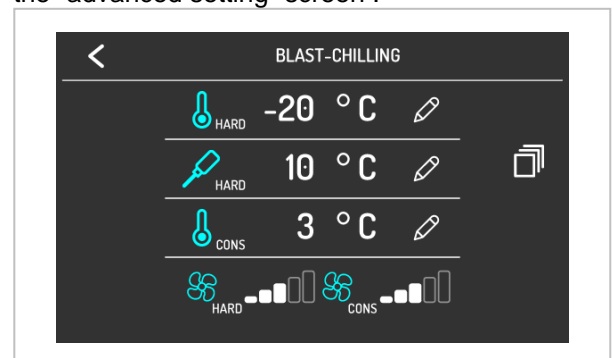

- Intensive blast chilling (HARD)
- standard blast chilling
- conservation

Pressing the  area, the controller displays the “advanced setting” screen :

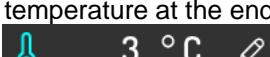

Within this mode, following values can be changed :

-  cell temperature during the intensive phase ;
-  product temperature at the end of intensive cycle ;
-  cell temperature during the conservation phase ;

-  fun speed during the intensive phase ;
-  fun speed during the conservation.

To exit the “advanced settings” screen press  on the upper left display area.  
To confirm the blast chilling cycle settings press



the right lower area

If a standard chilling cycle has been selected, following screenshot will appear:

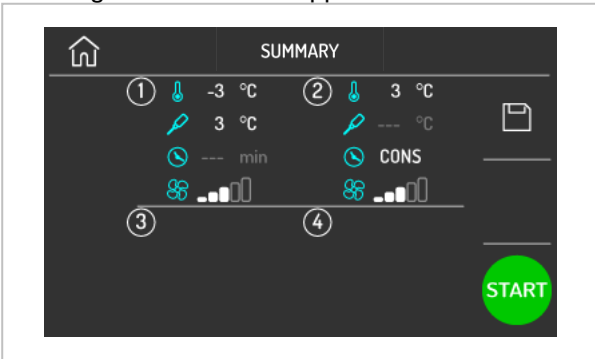

If an intensive chilling cycle (HARD) has been selected, following screenshot will appear:

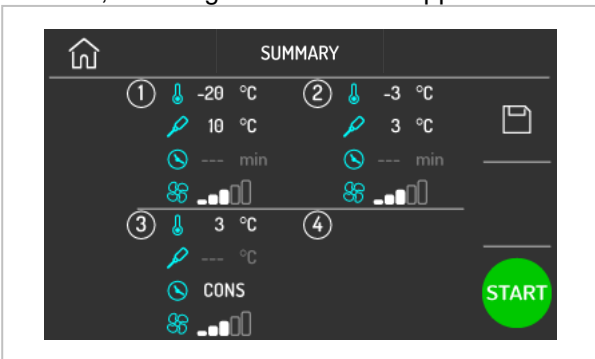

To change the values within the single phases, press in the area involved.

E.g. to change the temperature of the cell during the intensive phase, press in correspondence of phase 1; the screen of the first phase will be showed.







To save and store the set cycle press in correspondence of the area .

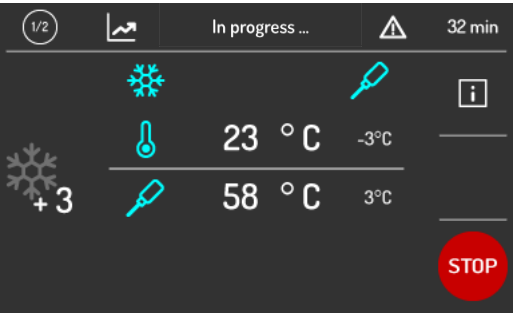

To start the cycle press in correspondence of the area . During a current cycle, following screenshot will be displayed :

Number of the current phase

Time left



	Positive blast chilling symbol
	Intensive blast chilling symbol
	Temperature cycle symbol

Pressing on the area  the display show the temperatures detected by the various probes, the state of inputs / outputs and the alarms stored by the system. To abort the current cycle, press for at least three seconds the area .



### Time Positive Blast Chilling Cycle

**i** This cycle lowers the temperature at the core of the product from **+ 90 ° C** to **+ 3 ° C** in the time set by the user. We recommend performing some test cycles to determine the needed time to properly chill the product. We remind you that acquired and eventually saved times are to be considered valid for the exclusive use of the same product type and at the same amount per cycle.

To switch to a timed cycle, press inside the blast chilling screen, the area : the system will shut down the temperature cycle area and illuminate the timed cycle area .

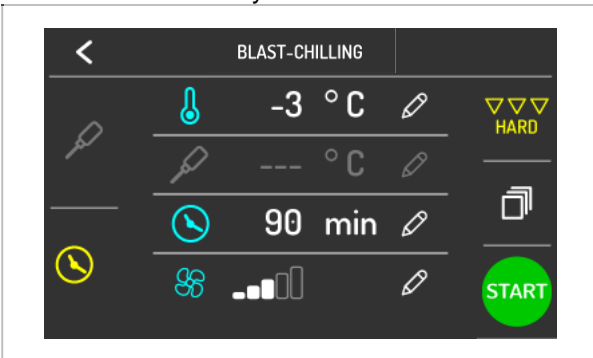

Pressing the area **-3 ° C** it is possible to change the operating cell temperature.

Pressing the area **90 min** it is possible to change the duration of the blast chilling cycle.

Pressing the area it is possible to change the fan speed during the blast chilling.

Pressing the area it is possible to change the cell temperature and the speed of the fans during the conservation phase

Press the area to enable the intensive phase: the relative area will be enlightened



In this case the positive chilling cycle will be divided into three stages :

- Intensive blast chilling (HARD)
- standard blast chilling
- conservation



Pressing the area, the controller displays the “advanced setting” screen :

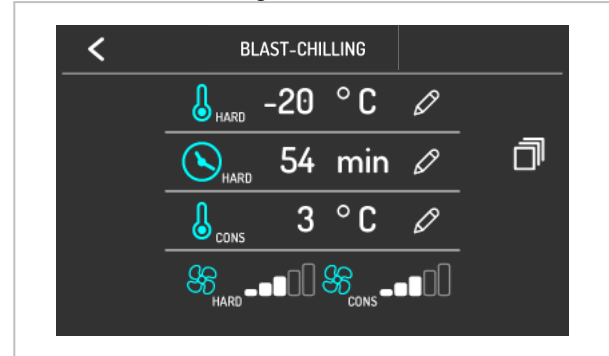

Within this mode, following values can be changed :

- **-20 ° C** cell temperature during the intensive phase ;
- **54 min** duration of the intensive phase ;
- **3 ° C** cell temperature during the conservation phase ;
- fan speed during the intensive phase ;
- fan speed during the conservation.

To exit the “advanced settings” screen press on the upper left display area.

To confirm the blast chilling cycle settings press

the right lower area .

If a standard chilling cycle has been selected, following screenshot will appear :

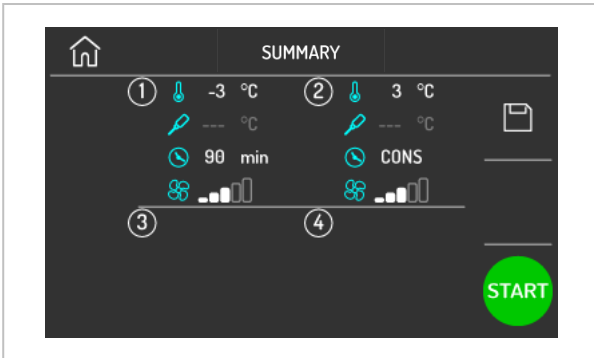

If an intensive chilling cycle (HARD) has been selected, following screenshot will appear :

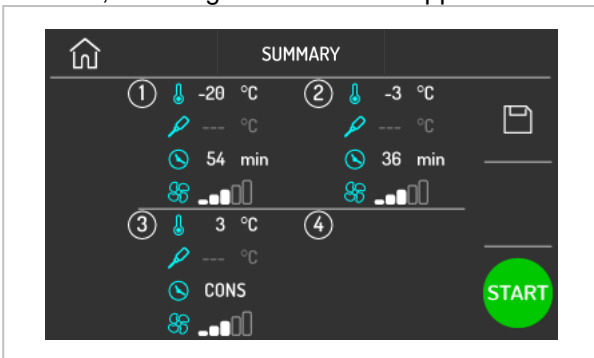

To change the values within the single phases, press in the area involved.

To save and store the set cycle press in



correspondence of the area

To start the cycle press in correspondence of the



area

During a current cycle, following screenshot will be displayed :

Number of the current phase

Time from cycle begin

	Positive blast chilling symbol
	Intensive blast chilling symbol
	Timed cycle symbol

Pressing on the area the display show the temperatures detected by the various probes, the state of inputs / outputs and the alarms stored by the system. To abort the current cycle press for at

least three seconds the area

GB



### Temperature Frosting Cycle

**i** This cycle lowers the temperature at the core of the product from **+ 90 ° C** to **- 18 ° C** in the shortest time possible and within a maximum time of **270 minutes**. The end of the cycle is determined by the achievement of the value **- 18 ° C** read by the core probe.

Selecting the freezing cycle, the system displays following screenshot :

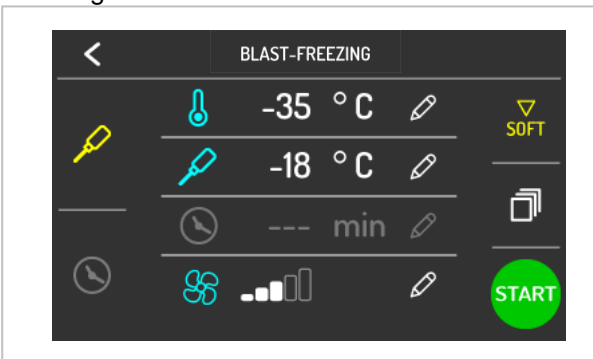



By default the system suggests the temperature cycle.

By pressing the area  it is possible to change the operating cell temperature.

By pressing the area  it is possible to change the product temperature at the end of the cycle.

By pressing the area  it is possible to change the fan speed during frosting.

Pressing the area  it is possible to change the cell temperature  and the speed of the fans  during the conservation phase.

Press the area  to enable the SOFT phase:

the relative area will be enlightened .

In this case the frosting cycle will be divided into three stages :





- SOFT frosting
- standard frosting
- conservation

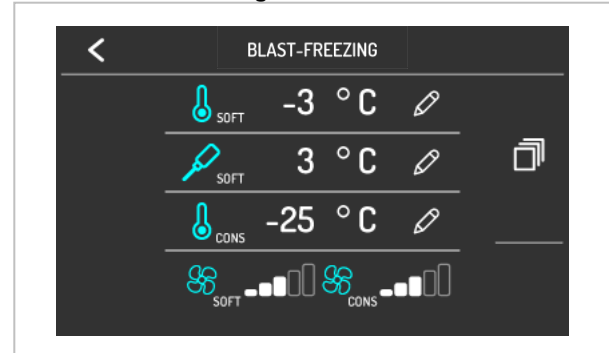

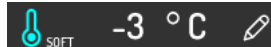

Pressing the  area, the controller displays the “advanced setting” screen :



Within this mode, following values can be changed :

-  cell temperature during the SOFT phase ;
-  product temperature at the end of the SOFT cycle;
-  cell temperature during the conservation phase ;
-  fan speed during the SOFT phase ;
-  fan speed during the conservation.

To exit the “advanced settings” screen press  on the upper left display area.

To confirm the frosting cycle settings press the right lower area .

GB

If a standard frosting cycle has been selected, following screenshot will appear :

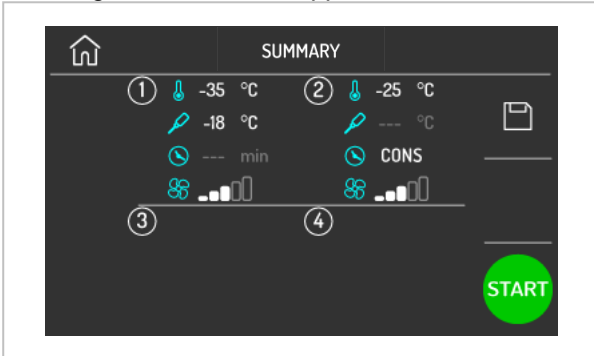

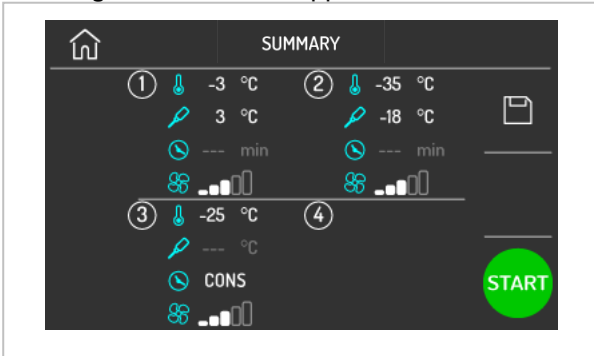

If a SOFT frosting cycle has been selected, following screenshot will appear :



To change the values within the single phases, press in the area involved.

To save and store the set cycle press in

correspondence of the area .

To start the cycle press in correspondence of the area .

Following screenshot will be displayed :

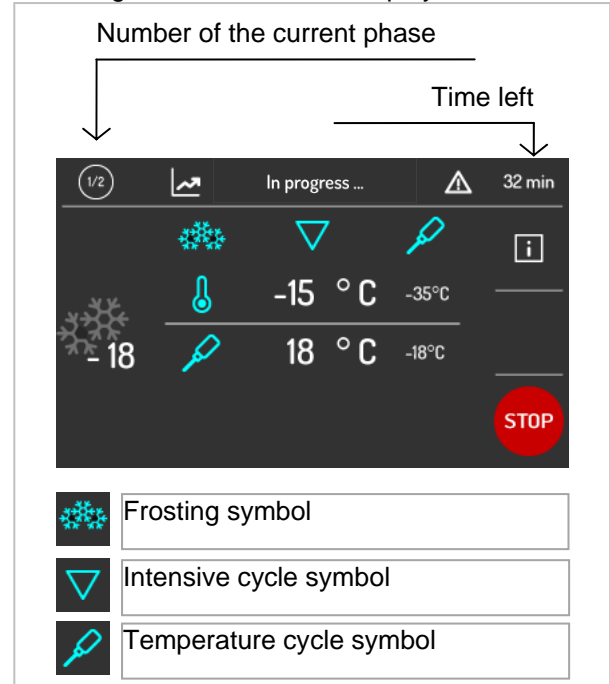

Pressing on the area  the display show the temperatures detected by the various probes, the state of inputs / outputs and the alarms stored by the system. To abort the current cycle press for at

least three seconds the area .

GB



**Timed Frosting Cycle**

**i** This cycle lowers the temperature at the core of the product from **+ 90 ° C** to **- 18 ° C** in the time set by the user. We recommend performing some test cycles to determine the needed time to properly chill the product. We remind you that acquired and eventually saved times are to be considered valid for the exclusive use of the same product type and at the same amount per cycle.

To switch to a timed cycle, press inside the frosting screen, the area : the system will shut down the temperature cycle area and illuminate the timed cycle area .

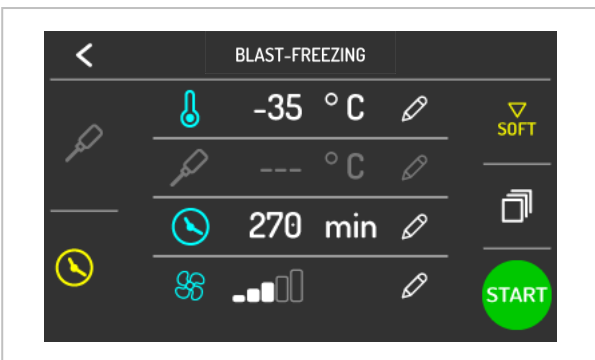

By pressing the area **-35 °C** it is possible to change the operating cell temperature.

By pressing the area **270 min** it is possible to change the duration of the frosting cycle.

By pressing the area it is possible to change the fan speed during freezing.

Pressing the area it is possible to change the cell temperature and the speed of the fans during the conservation phase.

Press the area to enable the SOFT phase: the relative area will be enlightened .

In this case the frosting cycle will be divided into three stages :

- SOFT frosting
- standard frosting

- conservation

Pressing the area, the controller displays the “advanced setting” screen :

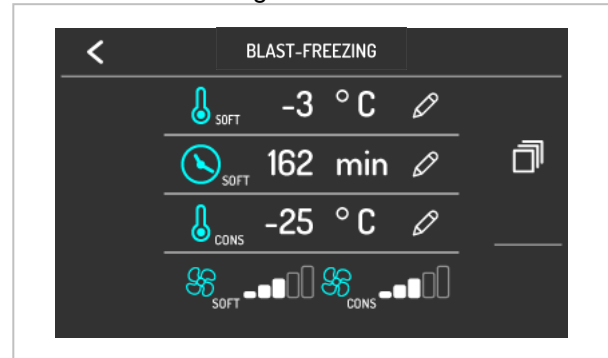

Within this mode, following values can be changed :

- **-3 °C** cell temperature during the SOFT phase ;
- **162 min** duration of the SOFT phase ;
- **-25 °C** cell temperature during the conservation phase ;
- fan speed during the SOFT phase ;
- fan speed during the conservation.

To exit the “advanced blast chilling” screen press on the upper left display area.

To confirm the frosting cycle settings press the right lower area .



If a standard frosting cycle has been selected, following screenshot will appear :

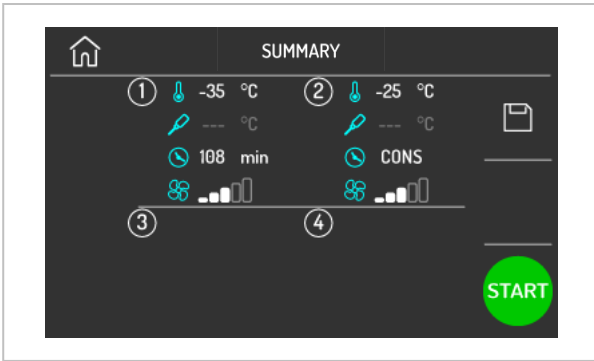

If a SOFT frosting cycle has been selected, following screenshot will appear :

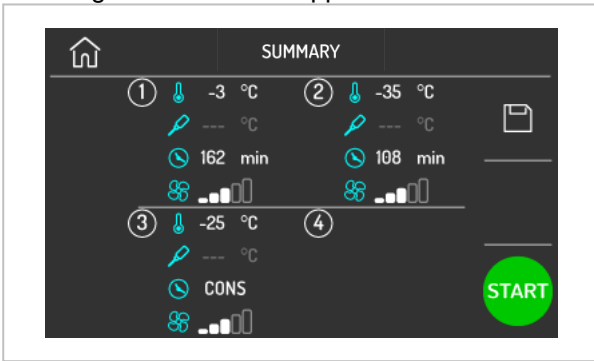

To change the values within the single phases, press in the area involved.

To save and store the set cycle press in



correspondence of the area

To start the cycle press in correspondence of the



area

During a current cycle, following screenshot will be displayed :

Number of the current phase

Time from cycle begin

	Frosting symbol
	Intensive cycle symbol
	Timed cycle symbol



Pressing on the area the display show the temperatures detected by the various probes, the state of inputs / outputs and the alarms stored by the system. To abort the current cycle press for at



least three seconds the area

GB



**Continuous Timed Cycle**

**i** This cycle can be used when large quantities of food are to be chilled and the specific chilling time of each product is known. Just set the cell temperature, the fan speed and start the machine. The appliance maintains the set temperature, the defrosting is automatically managed. The cell temperature can be changed during the normal operation.

By selecting the continuous timed cycle the system will propose following screenshot :

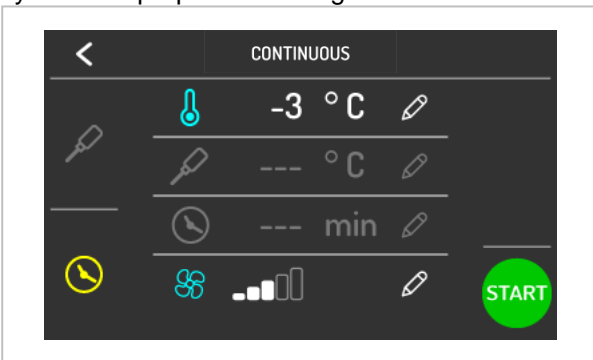

By pressing the area  it is possible to change the operating cell temperature.

By pressing the area  it is possible to change the fan speed.

To confirm the new settings press the  area on the right bottom : the cycle will start.

During a current cycle, following screenshot will be displayed :

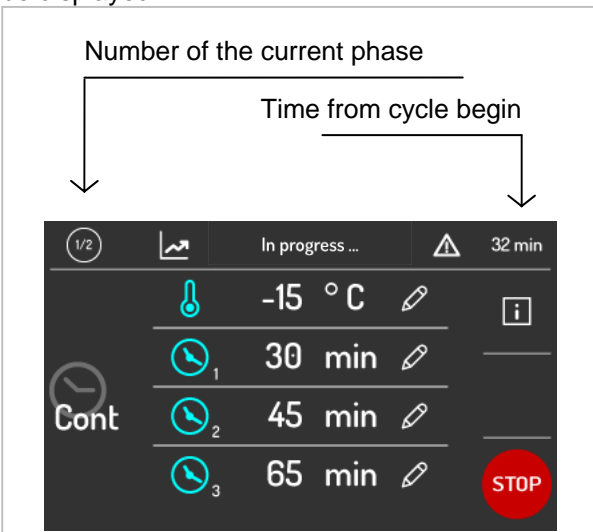



The cycle starts only by activating the first timer; it is possible to set up to three different timers. Timers can be set by pressing the pencil area and setting the time while the cycle is running.

When setting the time, once the timer is confirmed, its count starts directly. Each timer is independent and can be reset at its completion.

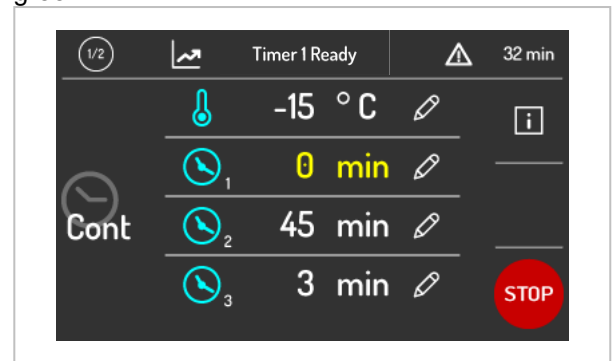
The cycle ends when all set timers have expired. At the end of a timer count, the buzzer sounds, the display shows a message and the value "0 min" of the corresponding timer is displayed in green.



Pressing on the area  the display show the temperatures detected by the various probes, the state of inputs / outputs and the alarms stored by the system. To abort the current cycle press for at

least three seconds the area .

GB



## Continuous Temperature Cycle

The continuous temperature cycle is available on condition that there are two or three product probes.

By selecting the continuous temperature cycle the system will propose following screenshot :

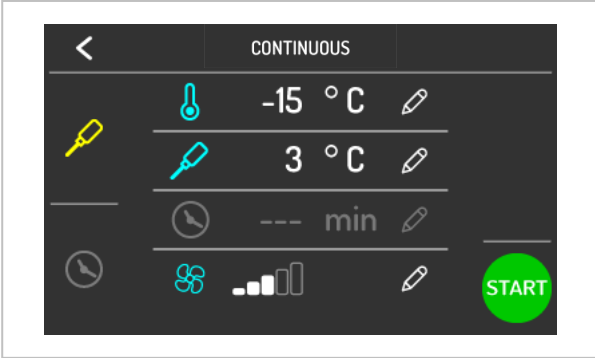

By pressing the area -15 °C it is possible to change the operating cell temperature.

By pressing the area 3 °C it is possible to change the product temperature at the end of the cycle.

By pressing the area it is possible to change the fan speed.

To confirm the new settings press the area on the right bottom : the cycle will start .  
During a current cycle, following screenshot will be displayed :

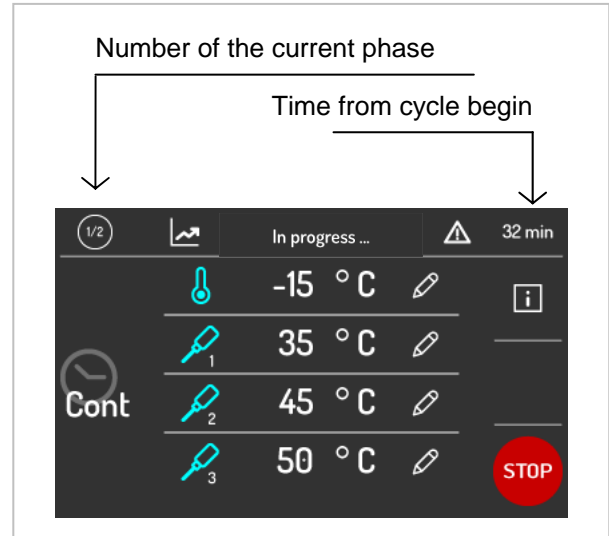

While executing the cycle, each time the door is closed, the system checks the proper insertion of the various probes and the cycle ends only when all inserted probes reach the desired temperature. After reaching the temperature set for each probe, the buzzer sounds, the display shows a message and the temperature value of the related probe is displayed in green. Below an example of a screen where only one probe is at temperature.

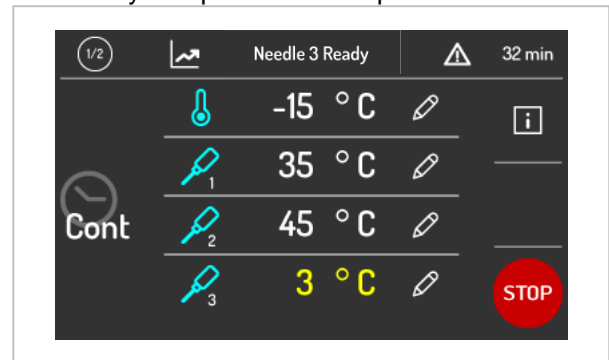

Pressing on the area the display show the temperatures detected by the various probes, the state of inputs / outputs and the alarms stored by the system. To abort the current cycle press for at

least three seconds the area .

**Cust** Custom Cycle

The function "custom" allows setting a cycle composed of a maximum of 4 phases (3 for the blast chilling and a conservation one) and can be composed of temperature phases and/or timed phases.

By selecting the custom cycle the system will propose following screenshot :

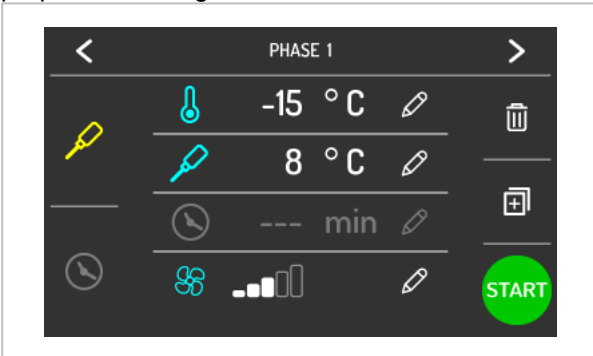



It is possible to switch the phase from core probe to timed and set the related set points.

To add a phase, press in correspondence of this

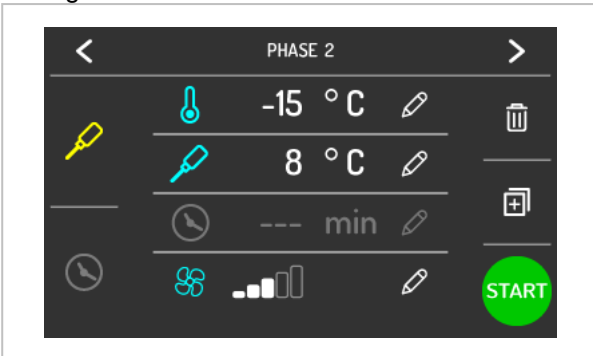

area. The phase will be added and proposed during editing.



To delete a phase press on the area . Once all desired phases are inserted and all settings are done, press the below area on the



right.

Before running a cycle it is possible to change the cell temperature  3 °C and the

speed of the fans  during the conservation phase.

To confirm the new settings press the below area



on the right : following screenshot will be displayed.

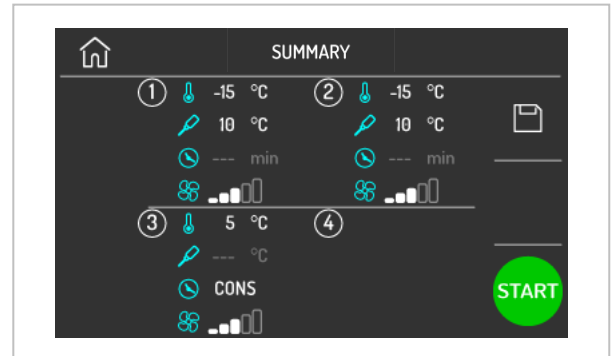

To change the values within the single phases, press in the area involved.

To save and store the set cycle press in

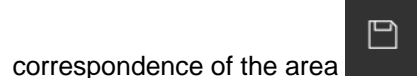

correspondence of the area

To run the cycle press in correspondence of the



area

During a current cycle, following screenshot will be displayed :

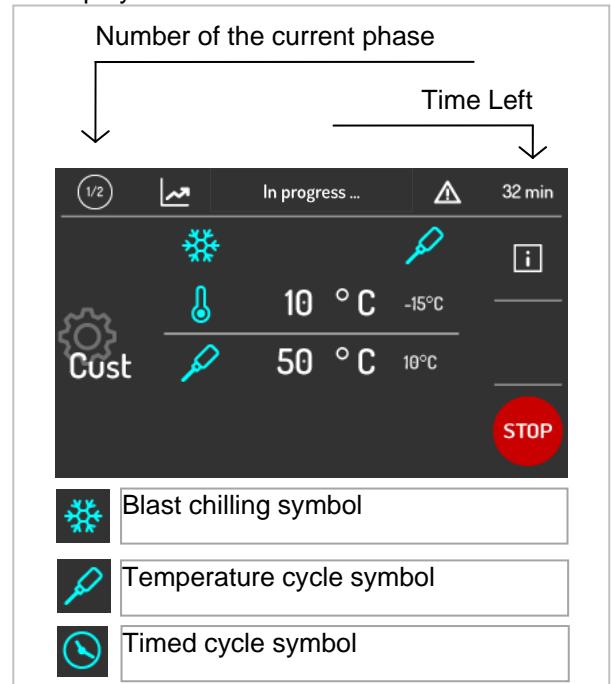

Pressing on the area  the display show the temperatures detected by the various probes, the state of inputs / outputs and the alarms stored by the system. To abort the current cycle press for at

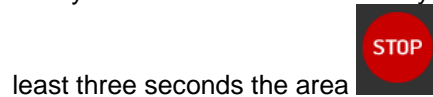

least three seconds the area

GB

### 5.3. Special Cycles Mode



By selecting the area  the menu SPECIAL CYCLES is loaded.

Proceed by selecting one of the available areas as needed:

1. sanitization
2. drying
3. manual defrosting
4. ice cream hardening
5. sterilization
6. thawing (optional)
7. proving (optional)
8. slow cooking (optional)



### Fish Sanitization Cycle

The function "Fish Sanitization" is divided into three phases :

1. negative temperature blast chilling phase
2. maintaining phase
3. conservation phase

By selecting the sanitification cycle the system shows the first phase screen :

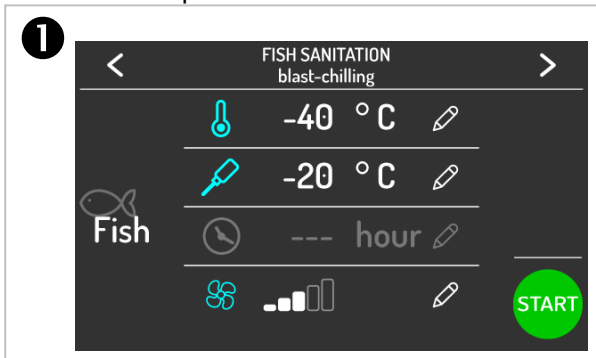

By pressing the area -40 °C it is possible to change the operating cell temperature during the blast chilling phase.

By pressing the area -20 °C it is possible to change the product temperature at the end of the cycle.

By pressing the area it is possible to change the fan speed.

Press in correspondence of the area at the right top to step to the second phase.

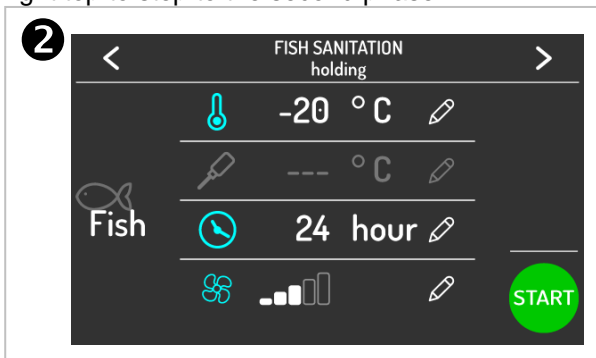

By pressing the area -20 °C it is possible to change the operating temperature of the cell during the maintaining phase.

By pressing the area 24 hour it is possible to change the duration of the maintaining phase.

By pressing the area it is possible to change the fan speed.

Press in correspondence of the area at the right top to step to the third phase.

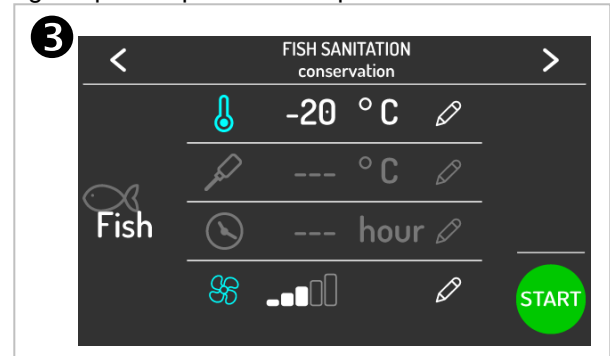

By pressing the area -20 °C it is possible to change the operating cell temperature during the conservation phase.

By pressing the area it is possible to change the fan speed.

To run the cycle press in correspondence of the area .

During a current cycle, following screenshot will be displayed :

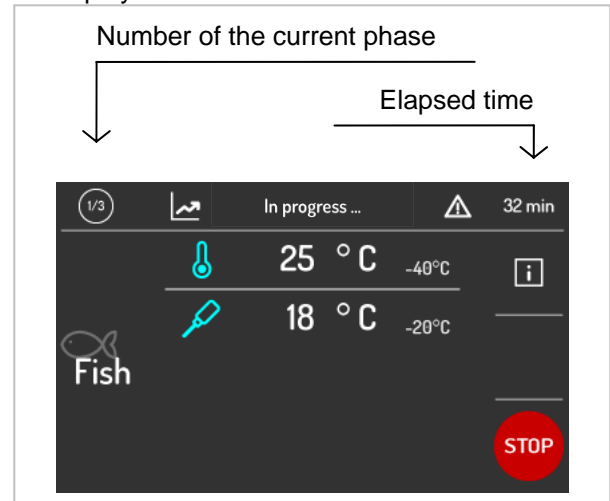

Pressing on the area the display show the temperatures detected by the various probes, the state of inputs / outputs and the alarms stored by the system. To abort the current cycle press for at

least three seconds the area .



### Drying Cycle

The “drying” function will run a cycle of forced ventilation.  
The opening of the door will not affect the running cycle.

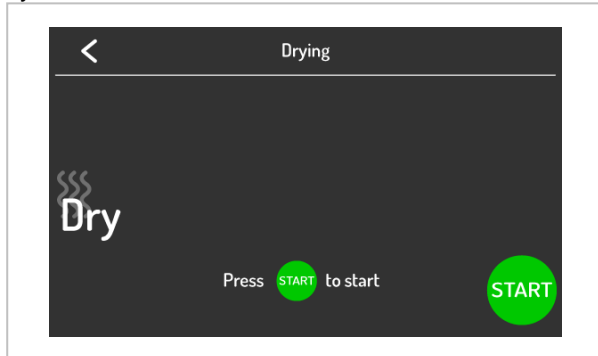

To run the cycle press in correspondence of the  area.

During a current cycle, following screenshot will be displayed :

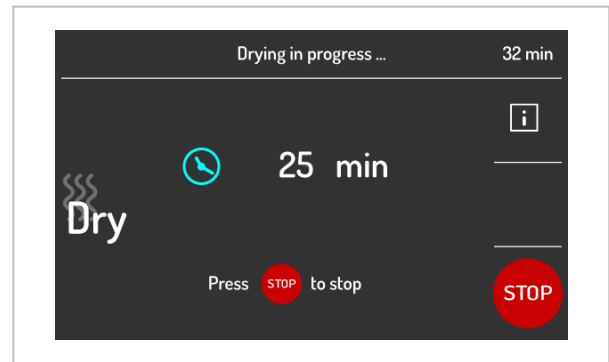

Pressing on the area  the display show the temperatures detected by the various probes, the state of inputs / outputs and the alarms stored by the system. To abort the current cycle press for at

least three seconds the area .

GB



### Defrosting Cycle

 The frost formed on the evaporator following the moisture deposit ceded by the product may compromise the proper operation of the equipment. To restore the full functionality it is necessary to perform a defrosting cycle. The defrosting is performed by forced ventilation using the evaporator fan. The cycle can be performed with the door open or closed and can also be interrupted at any time.

By selecting the manual defrosting cycle the system shows following screen:

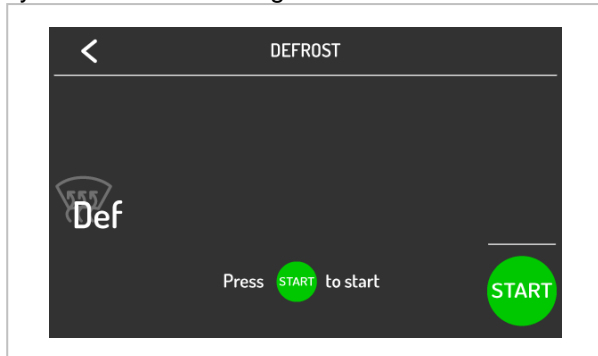

To run the cycle press in correspondence of the  area.

During a current cycle, following screenshot will be displayed :

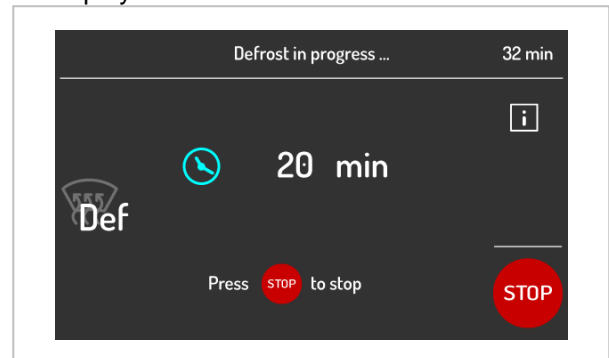

Pressing on the area  the display show the temperatures detected by the various probes, the state of inputs / outputs and the alarms stored by the system. To abort the current cycle press for at

least three seconds the area .



### Ice Cream Hardening Cycle

The ice cream hardening cycle is a timed freezing cycle. Temperature, duration and fan speed can be set. The system proposes following screenshot:

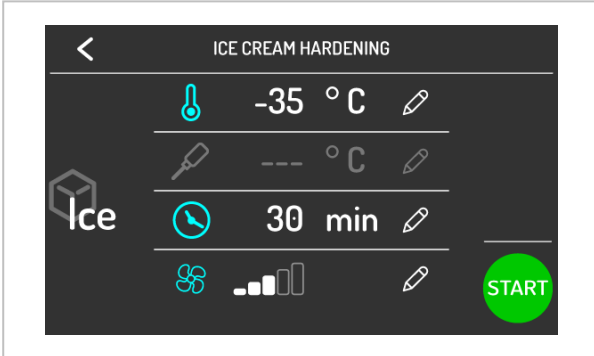

By pressing the area  it is possible to change the cell operating temperature.

By pressing the area  it is possible to change the duration of the freezing cycle.

By pressing the area  it is possible to change the fan speed.

To run the cycle press in correspondence of the



area

During a current cycle, following screenshot will be displayed :

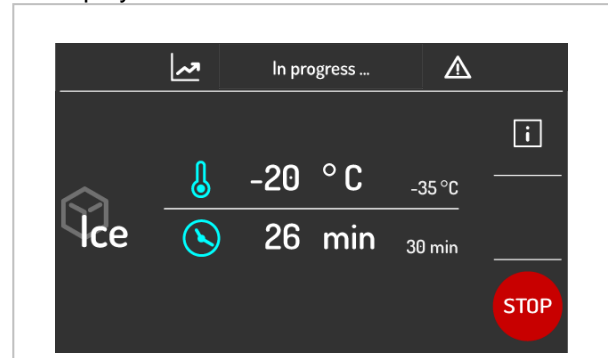

Pressing on the area  the display show the temperatures detected by the various probes, the state of inputs / outputs and the alarms stored by the system. To abort the current cycle press for at

least three seconds the area .

GB



### Sterilization Cycle

The running of the cycle is allowed only with the door closed and is immediately interrupted in the event that, during sterilization, the door is open. For a correct efficiency and hygiene of the machine it is recommended to perform the disinfection of the cell at the end of each shift.

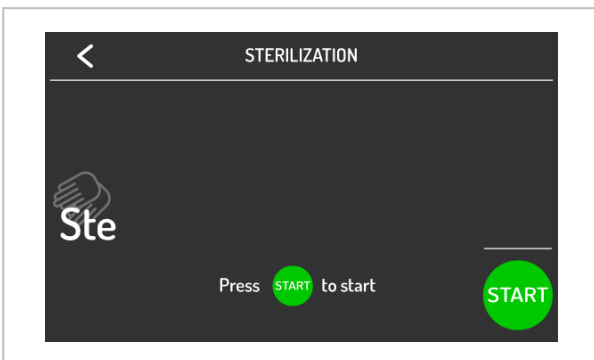

To run the cycle it is necessary to close the door of the blast chiller and press in correspondence of

the area .

During a current cycle, following screenshot will be displayed :

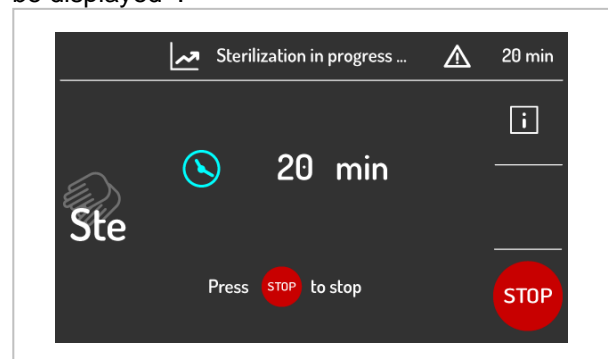

Pressing on the area  the display show the temperatures detected by the various probes, the state of inputs / outputs and the alarms stored by the system.

To abort the current cycle press for at least three seconds the area .



**i** Once the sanitization cycle by OZONE, starts a rest cycle lasting 20 minutes. It is not allowed to interrupt a rest cycle. During the off cycle, following screenshot will be displayed :

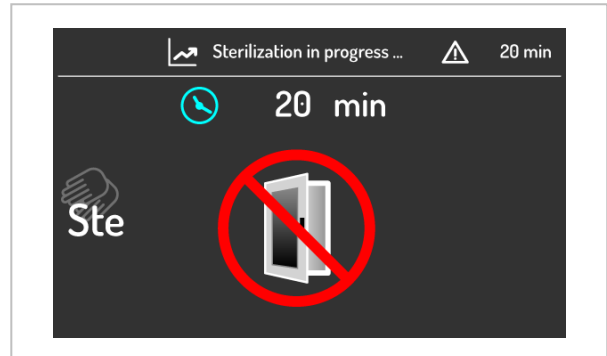

3 cycles over a period of 24 hours are sufficient to sanitize the internal cell.

GB

**Cor** Heating Cycle Product Probe

Use this functioning cycle when the core probe has to be extracted from the frozen product. The system proposes following screenshot:

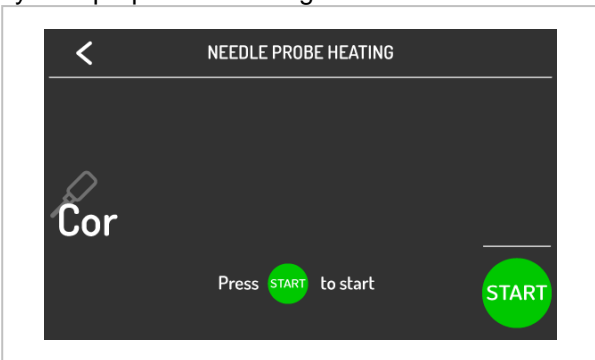

To run the cycle it is necessary to open the door of the blast chiller, and press in correspondence



of the area. During a current cycle, following screenshot will be displayed :

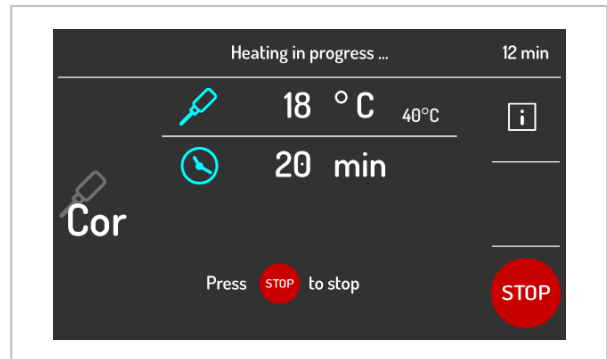

Pressing on the area **i** the display show the temperatures detected by the various probes, the state of inputs / outputs and the alarms stored by the system. To abort the current cycle press for at



least three seconds the area

**Tha** Thawing Cycle (Optional)

The thawing cycle is managed according to the amount of product inside the appliance to be defrosted. Three loading levels are foreseen. For each of the three levels, the system loads three different sets of parameters for the temperature control, the cycle time and the speed of the fans. The system proposes following screenshot :

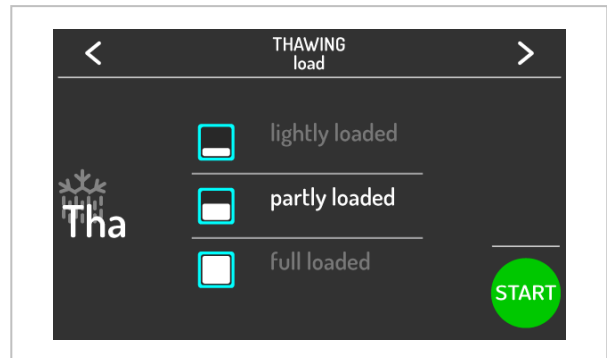

To run the cycle press in correspondence of the area  area.

During a current cycle, following screenshot will be displayed :

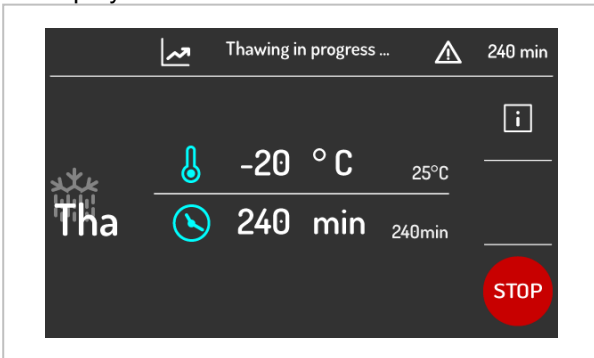

Pressing on the area  the display show the temperatures detected by the various probes, the state of inputs / outputs and the alarms stored by the system. To abort the current cycle press for at

least three seconds the area .





### Proving Cycle (Optional)

The system provides complete control of the proving cycle. The cycle is divided into four phases :

- **blast chilling phase** : blocks the leavening of the just prepared product and placed into the appliance
- **awakening phase** : awakens the yeast in the dough through a gradual rise in temperature in the cell
- **proving phase** : completes the leavening of the dough in order to make it ready for the subsequent baking
- **conservation phase** : It maintains the dough leavened at an optimal temperature for the subsequent baking.

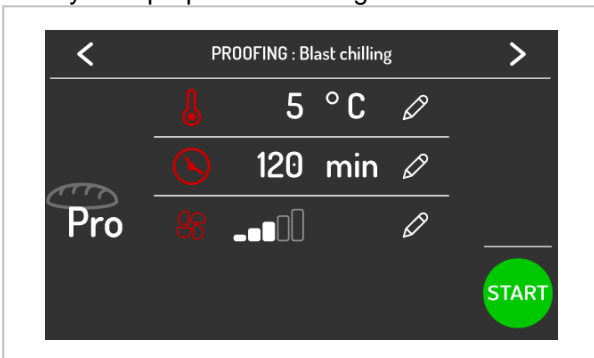
The system proposes following screenshot :



By pressing the area  it is possible to change the cell operating temperature.

By pressing the area  it is possible to set the duration of the chilling cycle.

By pressing the area  it is possible to change the fan speed.

Press in correspondence of the area  at the right top to step to the second phase.

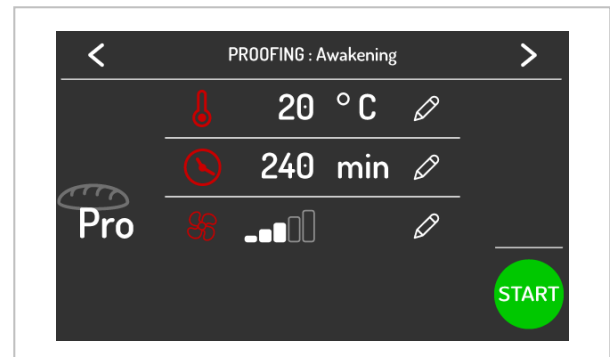

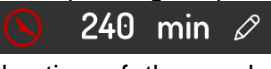

By pressing the area  it is possible to change the cell operating temperature.

By pressing the area  it is possible to set the duration of the awakening cycle.

By pressing the area  it is possible to change the fan speed.

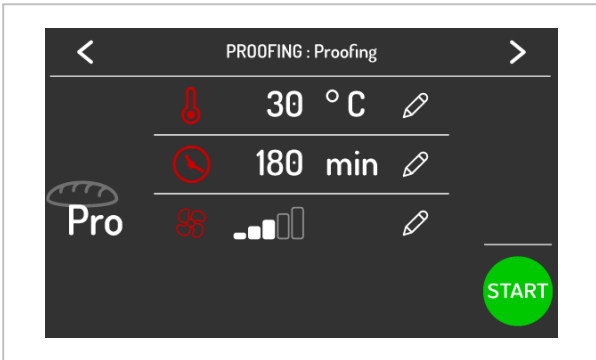
Press in correspondence of the area  at the right top to step to the third phase.



By pressing the area  it is possible to change the cell operating temperature.

By pressing the area  it is possible to set the duration of the leavening cycle.

By pressing the area  it is possible to change the fan speed.

Press in correspondence of the area  at the right top to step to the fourth and last phase : conservation.

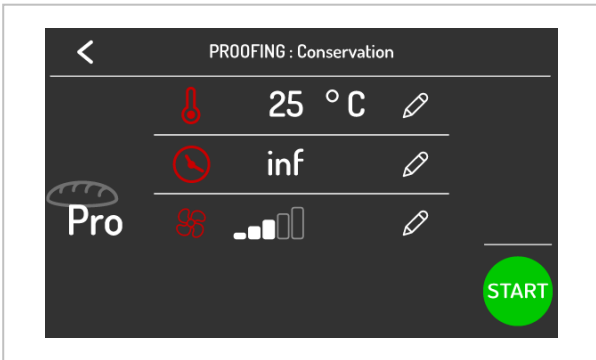

By pressing the area  it is possible to change the cell operating temperature.

By pressing the area  it is possible to change the fan speed.

To run the cycle press in correspondence of the



area. During a current cycle, following screenshot will be displayed :

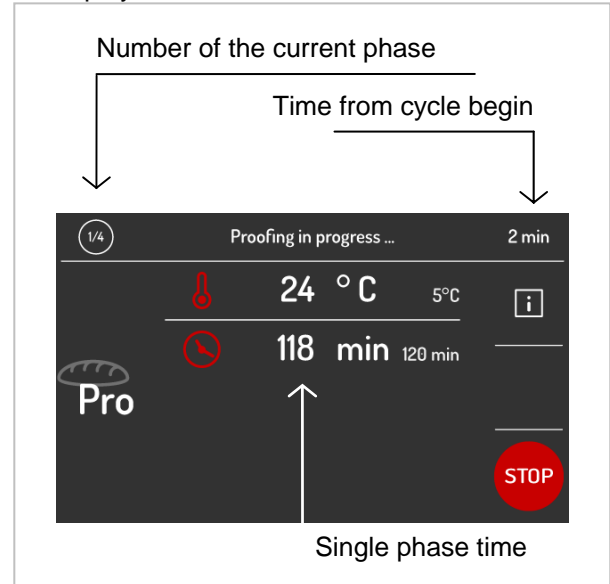



Pressing on the area  the display show the temperatures detected by the various probes, the state of inputs / outputs and the alarms stored by the system. To abort the current cycle press for at

least three seconds the area .

**Slo** Temperature Slow Cooking Cycle

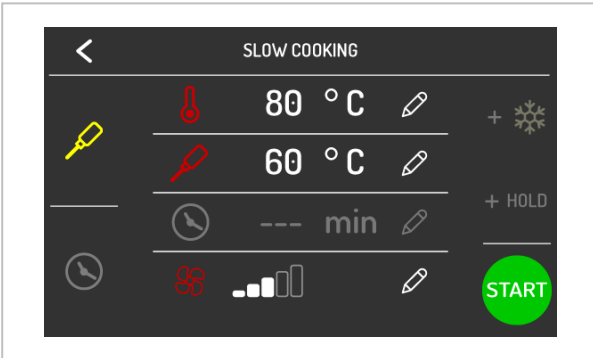
By selecting the slow cooking cycle at temperature, the system proposes following screenshot :



By pressing the area  it is possible to change the cooking chamber operating temperature.

By pressing the area  it is possible to change the product temperature at the end of the cycle.

By pressing the area  it is possible to change the fan speed during the slow cooking phase.

By pressing the area  after the slow cooking phase, a blast chilling phase will be enabled; the

corresponding area will be enlightened . The system proposes following screenshot :

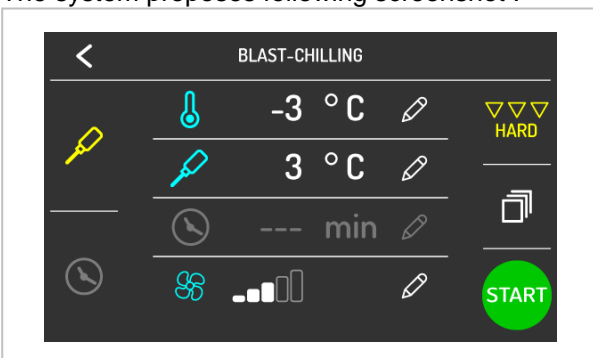

Within this screen it is possible to set various parameters related to the blast chilling phase (see chapter "Temperature Blast Chilling").

Press the area  on top on the left to go back to the slow cooking screen.

By pressing the area  after the slow cooking phase, a maintaining phase will be enabled; the

corresponding area will be enlightened . The system proposes following screenshot :

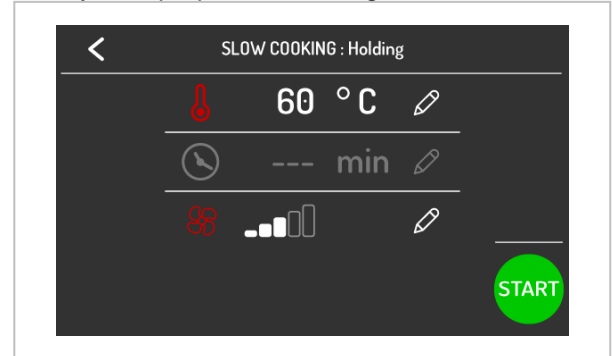

Within this screen it is possible to set various parameters related to the maintaining phase.

By pressing the area  it is possible to change the cooking chamber operating temperature during the maintaining phase.

By pressing the area  it is possible to change the fan speed.

Press the area  on top on the left to go back to the slow cooking screen.

To confirm the slow cooking cycle settings press the area  on the right bottom.

If a slow cooking cycle combined with a maintaining cycle has been selected, the display will look as follows :

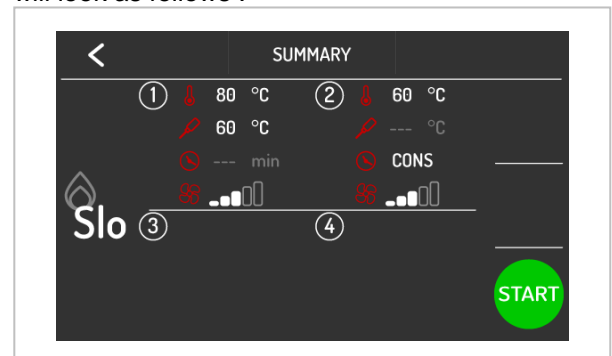

If a slow cooking cycle combined with an intensive blast chilling (HARD) cycle has been selected, the display will look as follows :

GB

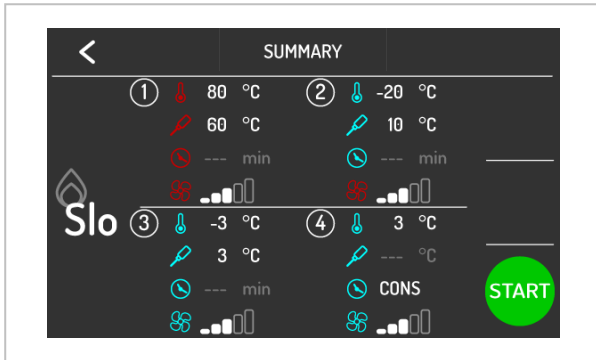

To change the values within the single phases, press in the area involved. E.g. to change the temperature of the cell during the slow cooking, press in correspondence of phase 1; the screen of the first phase will be showed.

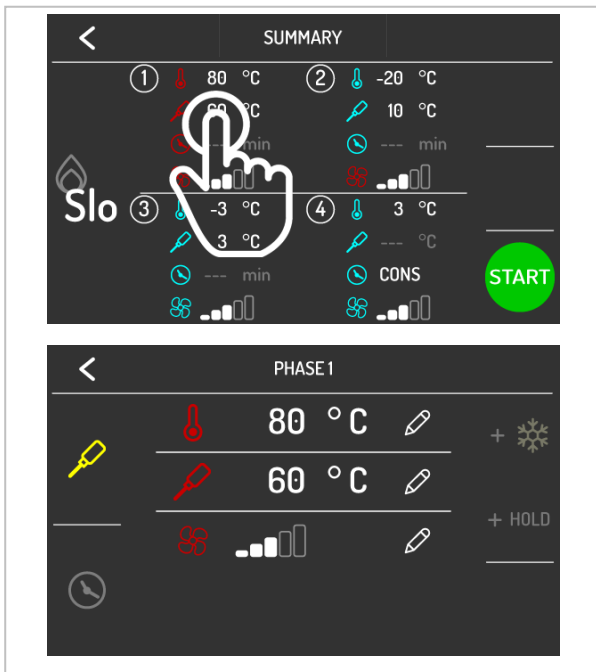

To run the cycle press in correspondence of the



area. Following screenshot will be displayed :

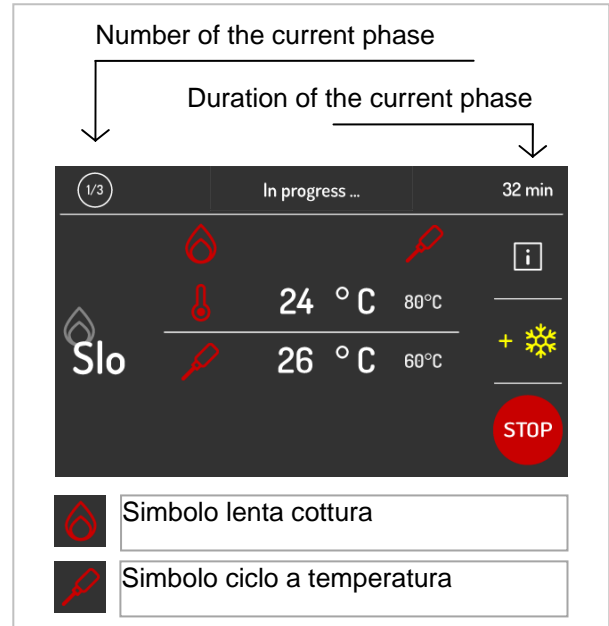

Pressing on the area  the display show the temperatures detected by the various probes, the state of inputs / outputs and the alarms stored by the system.

If the maintaining phase has been selected, by



pressing the area it is possible to abort the slow cooking phase and switch directly to the maintaining phase.

If the blast chilling phase has been selected, by



pressing the area it is possible to abort the slow cooking phase and switch directly to the blast chilling phase.

To abort the current cycle press for at least three





seconds the area.

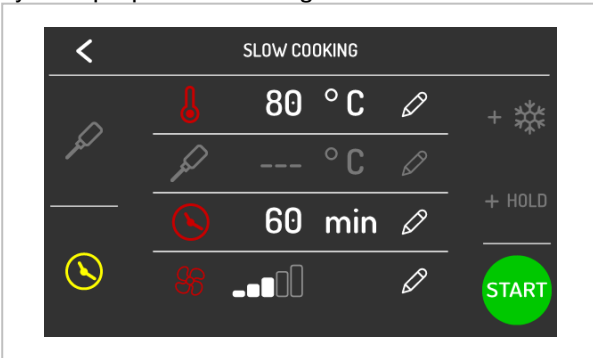

## Timed Slow Cooking Cycle

By selecting the timed slow cooking cycle, the system proposes following screenshot:



By pressing the area  it is possible to change the cooking chamber operating temperature.

By pressing the area  it is possible to change the duration of the slow cooking phase

By pressing the area  it is possible to change the fan speed.

By pressing the area  after the slow cooking phase, a blast chilling phase will be enabled; the

corresponding area will be enlightened . The system proposes following screenshot :

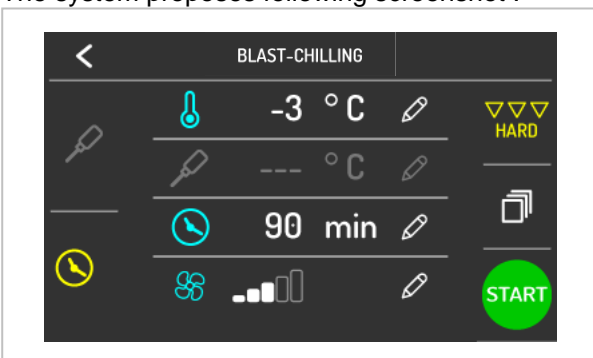

Within this screen it is possible to set various parameters related to the blast chilling phase (see chapter "Timed Blast Chilling").

Press the area  on top on the left to go back to the slow cooking screen.

By pressing the area  after the slow cooking phase, a maintaining phase will be enabled; the

corresponding area will be enlightened . The system proposes following screenshot :

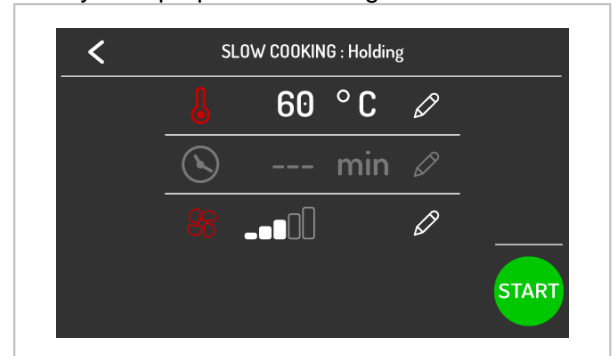

Within this screen it is possible to set various parameters related to the maintaining phase.

By pressing the area  it is possible to change the cooking chamber operating temperature during the maintaining phase.

By pressing the area  it is possible to change the fan speed.

Press the area  on top on the left to go back to the slow cooking screen.

To confirm the slow coking cycle settings, press the area  on the right bottom.

If a slow cooking cycle combined with a maintaining cycle has been selected, the display will look as follows:

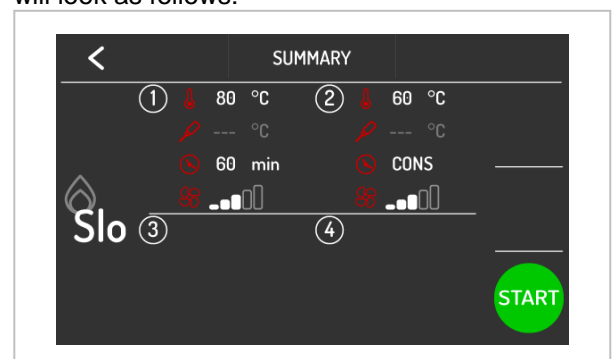

If a slow cooking cycle combined with an intensive blast chilling (HARD) cycle has been selected, the display will look as follows :

GB

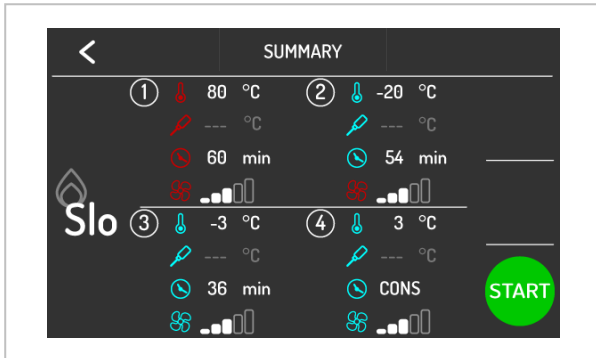

To change the values within the single phases, press in the area involved.

E.g. to change the temperature of the cell during the slow cooking, press in correspondence of phase 1; the screen of the first phase will be showed.

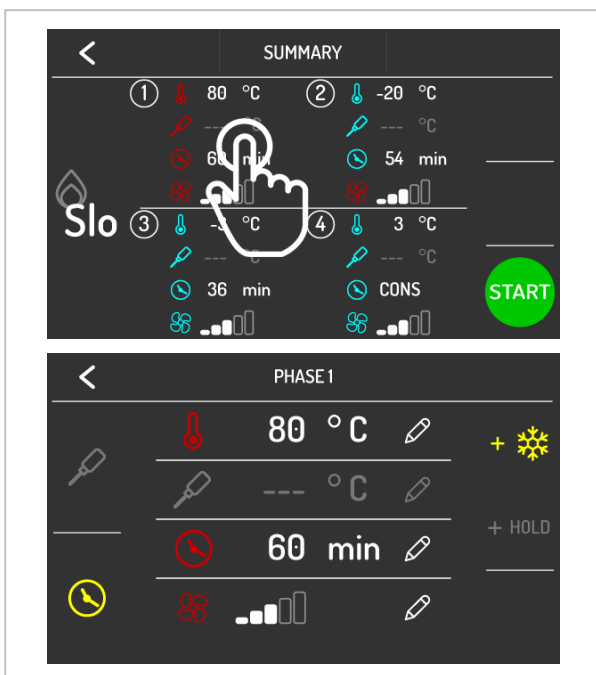

To run the cycle press in correspondence of the



area. Following screenshot will be displayed :

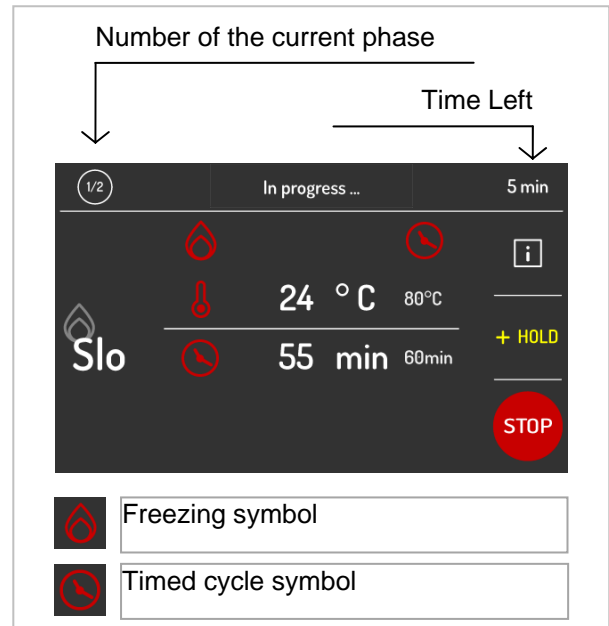

Pressing on the area  the display show the temperatures detected by the various probes, the state of inputs / outputs and the alarms stored by the system.

If the maintaining phase has been selected, by



pressing the area  it is possible to abort the slow cooking phase and switch directly to the maintaining phase.

If the blast chilling phase has been selected, by



pressing the area  it is possible to abort the slow cooking phase and switch directly to the blast chilling phase.

To abort the current cycle press for at least three



seconds the area .

## 5.4. Recipes Mode



Selecting the area  the menu RECIPES is loaded.

Recipes are divided by type :

- Blast chilling
- frosting
- proving (optional)
- slow cooking (optional)
- custom recipes.

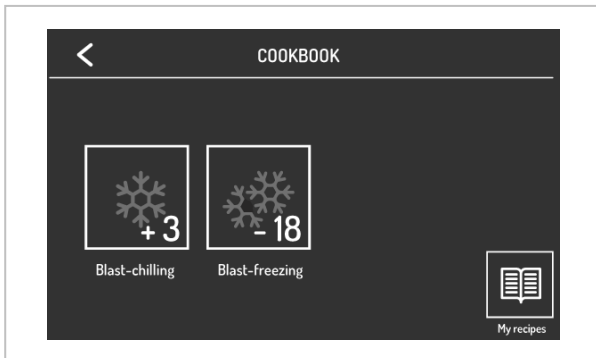

Selecting the area  it is possible to access the blast chilling recipes screen :

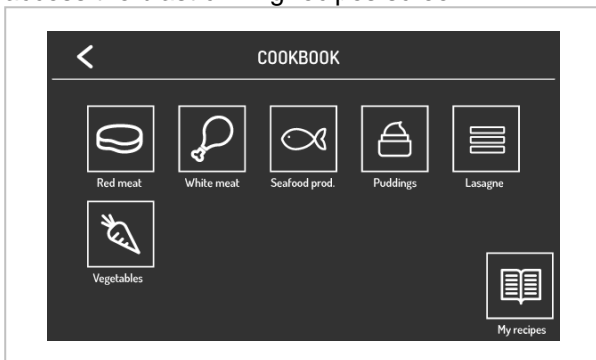

Selecting the area  it is possible to access the frosting recipes screen :

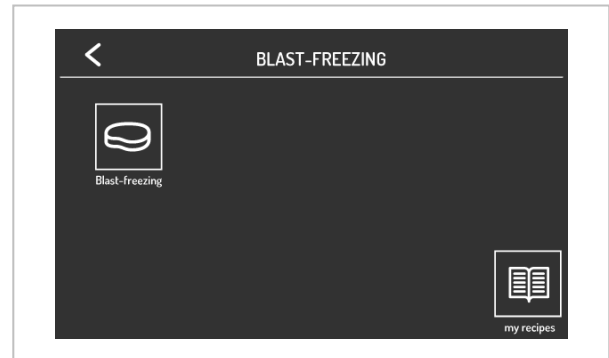

Selecting the area  it is possible to access recipes edited by the user.



The pressure of the area corresponding to the recipe opens a summary screen that displays the data set for the various phases of the recipe.

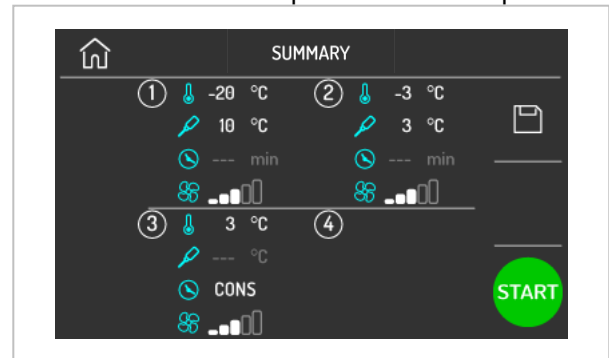

From this screen the execution of the recipe can be started, or the program setpoint can be changed by pressing the corresponding area of the phase.

After editing the data, following options are available:



- start the cycle without saving the change;
- save the change made by overwriting the program;
- save the change made with a new name.











**Blast Chilling Recipes**



Below our standard recipes :



<b>Red Meat</b>		
		
Phase 1	Set Cell	-25°C
	Set Probe	20°C
	Set Ventilation	5
Phase 2	Set Cell	-5°C
	Set Probe	3°C
	Set Ventilation	5
Conservation	Set Cell	5°C
	Set Probe	2°C
	Set Ventilation	5

<b>White Meat</b>		
		
Phase 1	Set Cell	-25°C
	Set Duration	27 min
	Set Ventilation	5
Phase 2	Set Cell	-5°C
	Set Duration	63 min
	Set Ventilation	5
Conservation	Set Cell	2°C
	Set Ventilation	5

<b>Fish Products</b>		
		
Phase 1	Set Cell	-25°C
	Set Duration	27 min
	Set Ventilation	5
Phase 2	Set Cell	-5°C
	Set Duration	63 min
	Set Ventilation	5
Conservation	Set Cell	2°C
	Set Ventilation	5

<b>crèmes</b>		
		
Phase 1	Set Cell	-5°C
	Set Duration	90 min
	Set Ventilation	2
Conservation	Set Cell	2°C
	Set Ventilation	2

<b>lasagna</b>		
		
Phase 1	Set Cell	-5°C
	Set Duration	90 min
	Set Ventilation	5
Conservation	Set Cell	2°C
	Set Ventilation	5



<b>vegetables</b>		
		
Phase 1	Set Cell	-5°C
	Set Duration	90 min
	Set Ventilation	5
Conservation	Set Cell	2°C
	Set Ventilation	5

GB



## Frosting recipes

Below our standard recipes:

<b>shock freezing</b>			
Phase 1	Set Cell	0°C	
	Set Probe	3°C	
	Set Ventilation	5	
Phase 2	Set Cell	-12°C	
	Set Probe	-3°C	
	Set Ventilation	5	
Phase 3	Set Cell	-30°C	
	Set Probe	-18°C	
	Set Ventilation	5	
Conservation	Set Cell	5°C	
	Set Probe	-20°C	
	Set Ventilation	5	



**Store a recipe**

It is possible to store both timed and at temperature cycles.

Various storage modes of a recipe are available. During conservation after a blast chilling/freezing



cycle, by pressing the **STOP** button, the device will suggest saving the just executed cycle :



It is possible to store a new recipe while setting a blast chilling / freezing cycle.

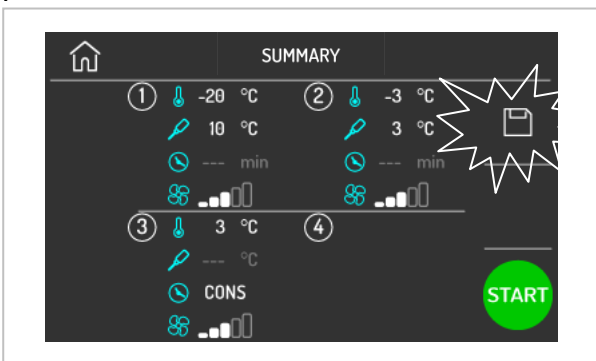



It is possible to select, change and save an existing recipe.

During the storage procedure vacant and occupied positions are displayed.

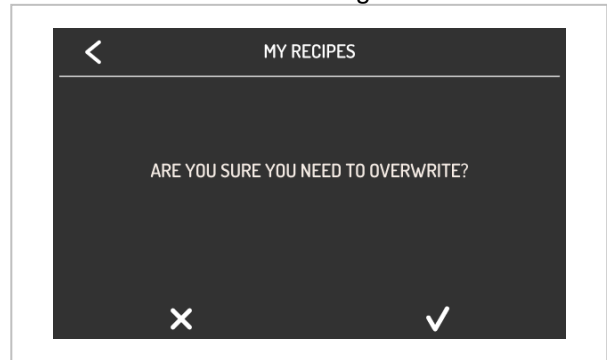

If an occupied position is selected, the system asks to confirm the overwriting.



By pressing in correspondence of the area  following screenshot is displayed, together with the writing editor to enter the name of the recipe.





## 5.5. Pre-cooling



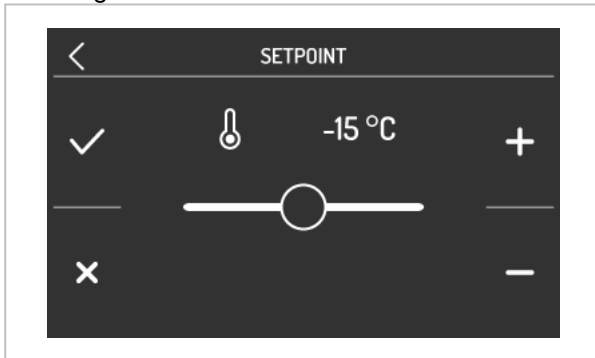

The pressure of the area  allows setting and starting a pre-cooling cycle. When pressing the corresponding area, the display shows following screenshot :





Press the area  and  to change the value of the temperature.

To undo the change press the area .

To exit without saving press the area .

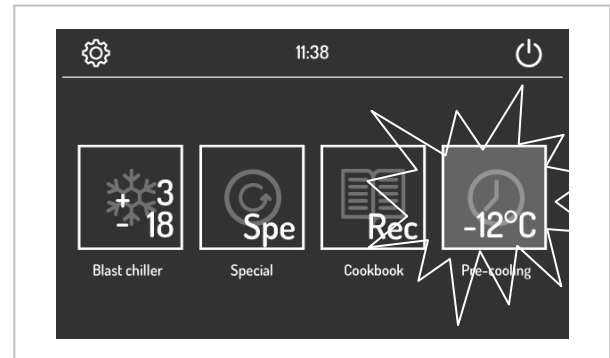
To confirm the changed value press ; the cycle will start with the new setpoint. Following screenshot is displayed :



From this screen additional cycles can be selected, or press the button  to lock the pre-cooling

Once the desired cell setpoint is reached, the buzzer sounds, the cycle continues maintaining the cell temperature reached until you press the button  or until the start of a chilling/freezing cycle. If a pre-cooling is in progress, it will be automatically locked to the selection and start of a cycle.

## 5.6. Settings

By pressing the key  on the home screen you can enter the SETTINGS menu. The page shows following menus:

- service;
- setup;
- language selection;

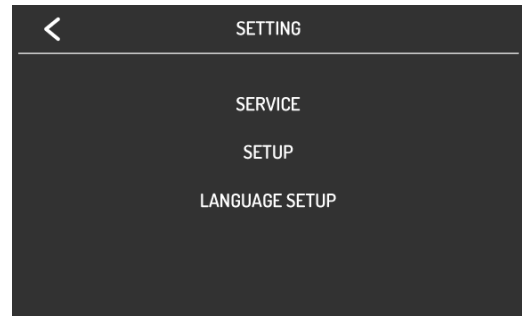

### Service

Inside the SERVICE area, it is shown a list of available functions as follows:

- alarms;
- inlets and outlets state;
- compressor working hours;
- Date/time setting;
- HACCP data selection;
- reset compressor working hours;
- reset HACCP alarms.

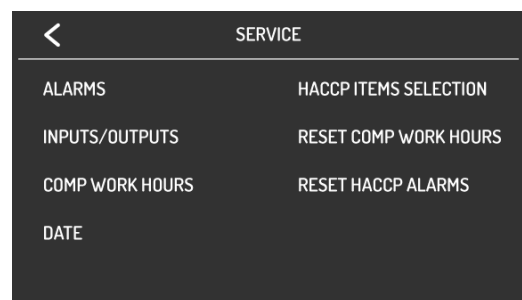

To enter the menu “reset compressor working hours” and “reset HACCP alarms” it is necessary to insert the password **149**.

### Setup

The access to the SETUP area is allowed only after inserting the password **-19**. From this area you can enter the function to :

- configure parameters;
- resetting the default values as per manufacturer's table.

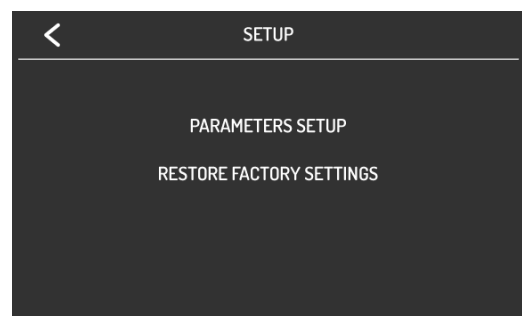

### Language Selection

From this area following languages can be selected:

- Italian;
- English
- French
- German
- Spanish
- Portuguese

## 5.7. Use of the USB port

Through the USB port you can perform the following operations :

- download and upload of recipes;
- download and upload of the configuration parameters;
- download of the information concerning the HACCP records.

The upload operations are allowed on condition that the firmwares of the source device and of the target device (or devices) are coincident.

To enter these functions, turn the board OFF and connect a USB device to the port.

Following screenshot will be displayed :

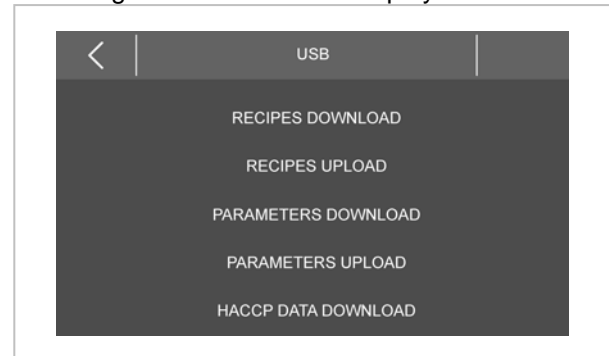

### Download and Upload of recipes

Once the USB device is connected, select the function "DOWNLOAD RECIPES" or "UPLOAD RECIPES", the writing (DOWNLOAD) or reading (UPLOAD) of the recipes will be automatically started in a text file named "**program.bin**"; the writing/reading operation can take few minutes.

At the end of the operation remove the USB device from the USB serial port.

### Download and Upload Parameters

Once the USB device is connected, select the function "DOWNLOAD PARAMETERS" or "UPLOAD PARAMETERS", the writing (DOWNLOAD) or reading (UPLOAD) of the parameters will be automatically started in a text

file named "**param.bin**"; the writing/reading operation can take few minutes.

At the end of the operation remove the USB device from the USB serial port.

### Download HACCP records

Once the USB device is connected, select the function "DOWNLOAD HACCP RECORDS", the writing will be started in a peripheral CSV document (Comma Separated Values). Take as example the file name "log247n00001.csv", this is composed as indicated:

"log" fix field

"247" value of the parameter LA (device address)

"n" fix field

"00001" progressive number of download of the HACCP alarms information.

The writing operation can take few minutes; at the end of the operation remove the USB device from the USB serial port.

## 5.8. Recommendations for Use

### Prolonged Inactivity

If the appliance remains inactive for a long period, proceed as follows:

1. Use the automatic isolating switch to deactivate connection to the main electrical line.
2. Clean the appliance and surrounding areas thoroughly;
3. Spread a thin layer of cooking oil onto the stainless steel surfaces;
4. Carry out all maintenance operations;
5. Leave the doors ajar to prevent the formation of mould and/or unpleasant odours.

### Recommendations for normal use

In order to ensure correct use of the appliance, it is good practice to apply the following recommendations:



Do not obstruct the zone in front of the condensing unit in order to favour heat disposal from the condenser to a maximum. Always keep the front of the condenser clean.



Do not insert foodstuffs that are well above the temperature of 90°C. As well as initially overloading the machine it can make protections intervene that prolong temperature descent times. If possible, a brief external period is useful to lower the temperature to acceptable values. Check the planarity of the appliance rest surface.



Do not stack the materials to be preserved in contact with the internal walls, so blocking the circulation of air, which guarantees uniformity of the internal temperature of the refrigerated compartment.



There must be a sufficient space between the basins and trays used in order to guarantee a sufficient flow of cold air on the entire product. Therefore avoid the following positions of trays and/or basins stated below.



Never obstruct the inlet of the evaporator fans.



Products that are more difficult to chill because of their composition and size should be placed in the centre.

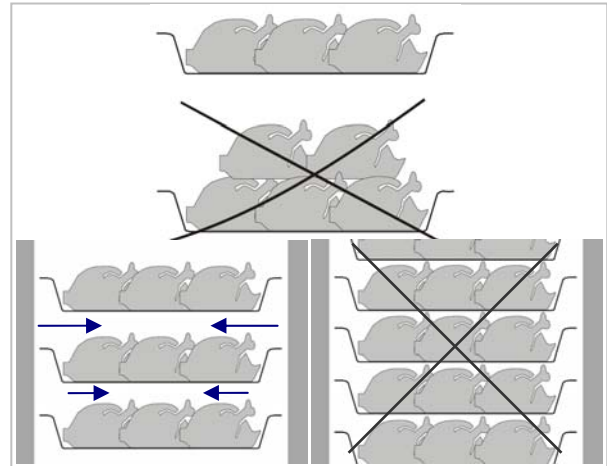

Limit the number of times and the duration of time the doors are opened.



Blast chilling data refer to standard products (low fat content) with a thickness below 50 mm; therefore avoid overlaying products or the insertion of pieces with a much higher thickness. This would, in fact, lead to an extension of blast chilling times. Always distribute the product well on the trays or basins or in the case of thick pieces decrease the amount to blast chill.



After blast chilling/shock freezing the product, it can be stored in a preservation cabinet after having been duly protected. A tag should be applied describing the contents of the product, blast chilling/shock freezing date and expiry date. *When the product has been blast chilled it must be preserved at a constant temperature of +2°C, while if it has been shock frozen it must be preserved at a constant temperature of -20°C.*



The chiller should be used for storage for short periods only.



**To prevent bacterial contamination or contamination of any other biological nature, the needle probe must be disinfected after use.**



To extract the product that has undergone blast chilling or shock freezing, always wear gloves to protect the hands, as "burns" may occur from the cold.

## 6. CLEANING AND MAINTENANCE

### 6.1. Recommendations for Cleaning and Maintenance



Activate all envisioned safety devices before carrying out any maintenance interventions. In

particular, deactivate the electrical power supply using the automatic isolating switch.

### 6.2. Routine Maintenance

Routine maintenance consists of daily cleaning of all the parts which can come into contact with foodstuffs and the periodic maintenance of the burners, nozzles and draining pipes.

Correct maintenance allows the user to maximise performance levels and operating life and constantly maintain safety requirements.

Do not spray the appliance with direct jets of water or using high pressure appliances.

Do not use iron wool, brushes or scrapers to clean the stainless steel as ferrous particles could be deposited which, on oxidising, could lead to rust.

To remove hardened residues, use wooden or plastic spatulas or abrasive rubber pads.

During long periods of inactivity, spread a protective layer on all stainless steel surfaces by wiping them with a cloth soaked in Vaseline oil and airing the rooms periodically.



Do not use products which contain substances which are harmful and dangerous for personal health (solvents, petrol etc.).

**At the end of the day** it is advisable to clean:

- the cooling compartment
- the appliance.



### 6.3. Extraordinary Maintenance (5T Version)

Have the following operations carried out **periodically** by specialised staff:

- Check the perfect sealing of the door gaskets and replace them if necessary.
- Check that the electric connections have not loosened.
- Check the efficiency of the heating element resistance
- Check functioning of the board and probes.
- Check the efficiency of the electrical system.
- Clean the evaporator.
- Clean the condenser.

#### Cleaning the evaporator

Clean the evaporator **periodically**.

**⚠** As the fins of the evaporator are very sharp, always wear protective gloves for the next phases. Only a brush must be used for cleaning: do not use jets of liquid or sharp instruments. To access the evaporator proceed as follows:

1. Open the door (A) of the appliance.
2. Loosen the two screws (B) on the right of the deflector.
3. Remove the runners (C):
4. Turn the deflector (D) to the left

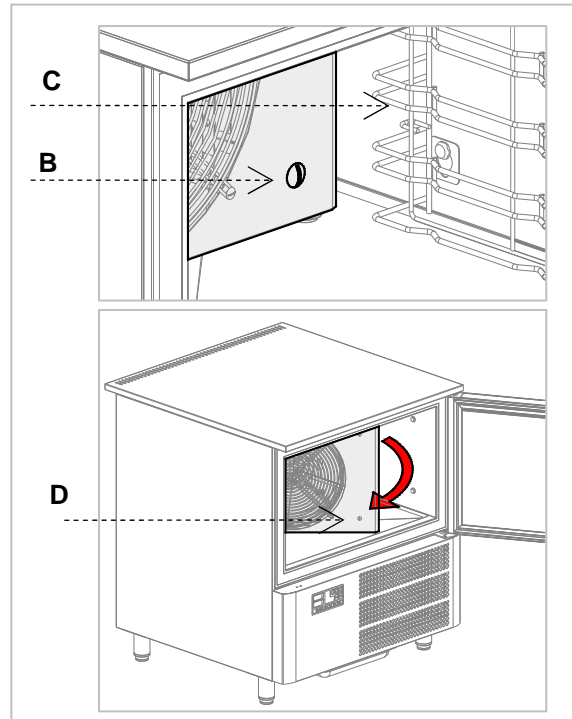
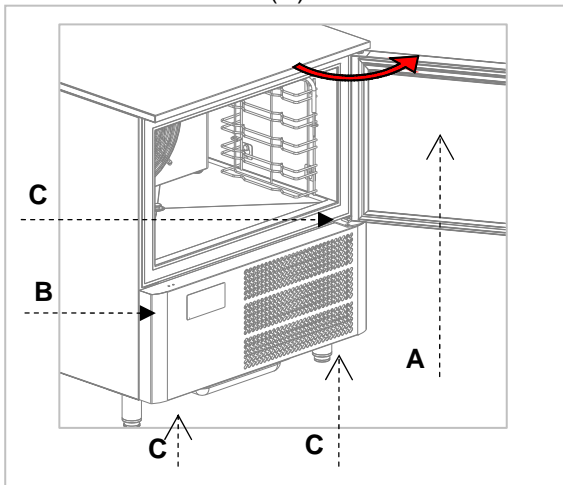

#### Cleaning the condenser

Clean the condenser **periodically**.

**⚠** As the fins of the condenser are very sharp, always wear protective gloves for the next phases. Use protective masks and glasses in the presence of dust.

**i** Whenever the condenser has a deposit of dust in correspondence with the fins, this can be removed using a suction device or with a brush applied, using a vertical movement along the direction of the fins.

**⚠** No other instruments must be used, which may deform the fins and therefore the efficiency of the appliance.

To clean, proceed as follows:

1. Open the door (A) of the appliance.
2. Remove the lower panel (B) from the technical compartment: to do this, remove the screw fasteners (C).
3. It is now possible to clean the finned part of the condenser (D) using suitable tools and protection devices.
4. After cleaning, close the control panel and fix it with the screws removed beforehand.

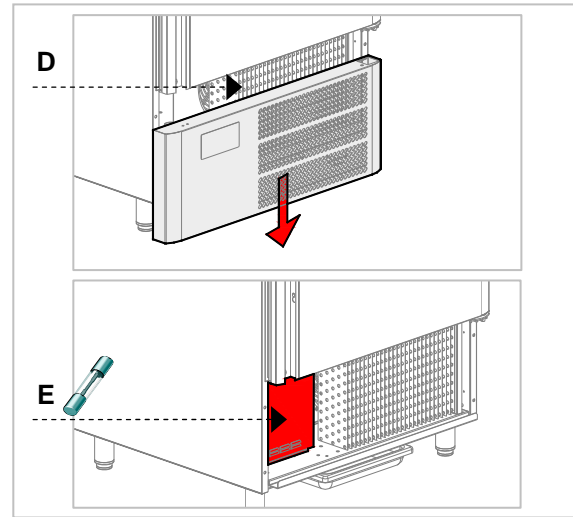
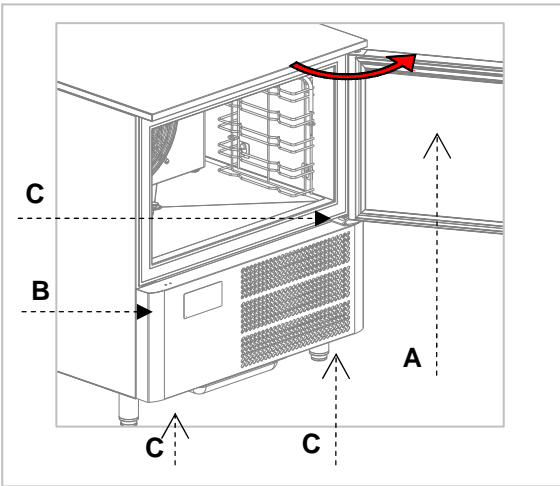

### Replacing the fuses

**i** The fuses are in the lower part of the technical compartment (E). To access these, open

the control panel using the same method listed for the access and cleaning of the condenser.

### U.V. Lamp Replacement

After having removed the flush sliders, remove the screws that fix the evaporator deflector onto the right side (A).

Access the UV lamp. This lamp can be removed by sliding it upwards (B). Carry out all the operations in reverse order after having removed the U lamp.

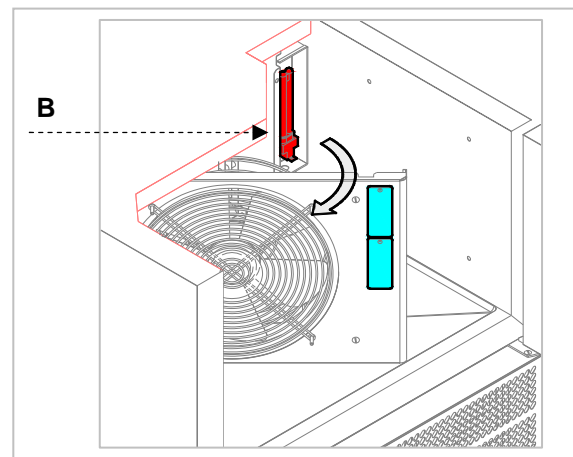
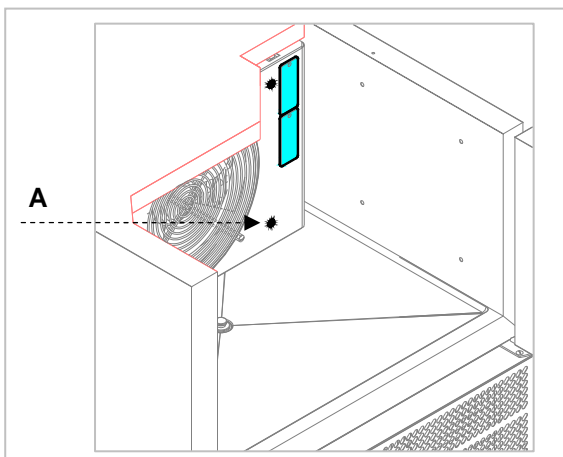

Once you have removed the screws, the evaporator deflector can be opened by turning it.

## 6.4. Extraordinary Maintenance (TABLE Version)

Have the following operations carried out **periodically** by specialised staff:

- Check the perfect sealing of the door gaskets and replace them if necessary.
- Check that the electric connections have not loosened.
- Check the efficiency of the heating element resistance
- Check functioning of the board and probes.
- Check the efficiency of the electrical system.
- Clean the evaporator.
- Clean the condenser.

### Cleaning the evaporator

Clean the evaporator **periodically**.

**⚠** As the fins of the evaporator are very sharp, always wear protective gloves for the next phases. Only a brush must be used for cleaning: do not use jets of liquid or sharp instruments. To access the evaporator proceed as follows:

5. Open the door (A) of the appliance.
6. Loosen the two screws (B) on the right of the deflector.
7. Remove the runners (C):
8. Turn the deflector (D) to the left

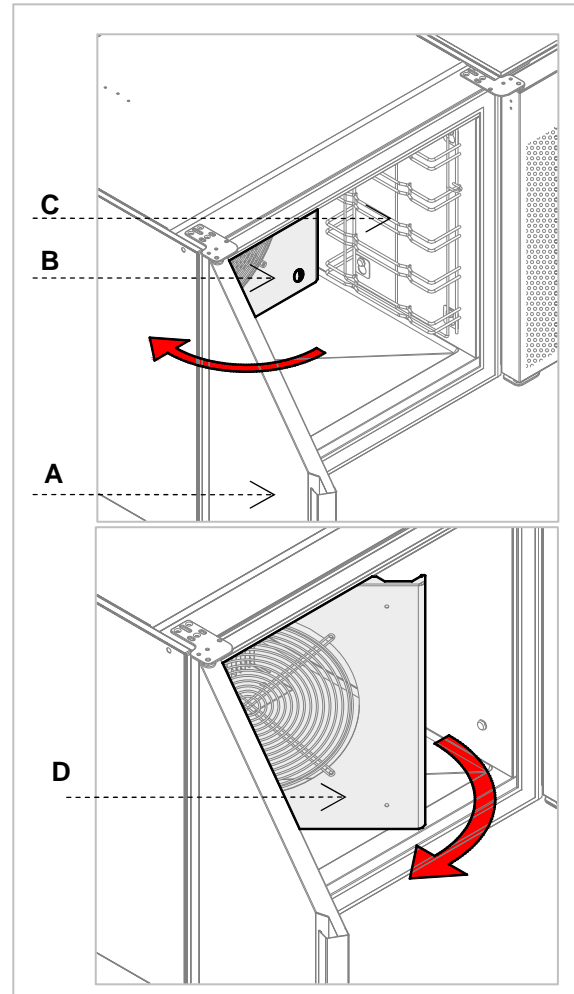

### Replacing the fuses

**i** The fuses are in the lower part of the technical compartment (E). To access these, open the control panel using the same method listed for the access and cleaning of the condenser.

## Cleaning the condenser

Clean the condenser **periodically**.

**⚠** As the fins of the condenser are very sharp, always wear protective gloves for the next phases. Use protective masks and glasses in the presence of dust.

**i** Whenever the condenser has a deposit of dust in correspondence with the fins, this can be removed using a suction device or with a brush applied, using a vertical movement along the direction of the fins.

**⚠** No other instruments must be used, which may deform the fins and therefore the efficiency of the appliance.

To clean, proceed as follows:

5. Open the door (A) of the appliance.
6. Turn the lateral panel (B) from the technical compartment: to do this, remove the screw fasteners (C).
7. It is now possible to clean the finned part of the condenser (D) using suitable tools and protection devices.
8. After cleaning, close the control panel and fix it with the screws removed beforehand.

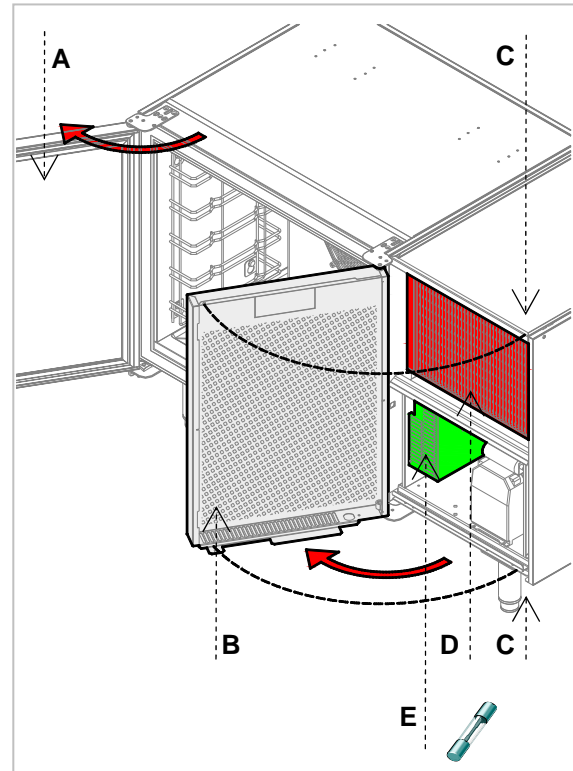

## U.V. Lamp Replacement

After having removed the flush sliders, remove the screws that fix the evaporator deflector onto the right side (A).

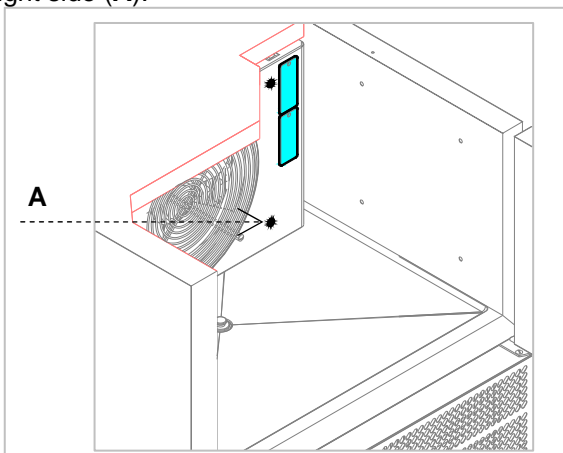

Once you have removed the screws, the evaporator deflector can be opened by turning it. Access the UV lamp. This lamp can be removed



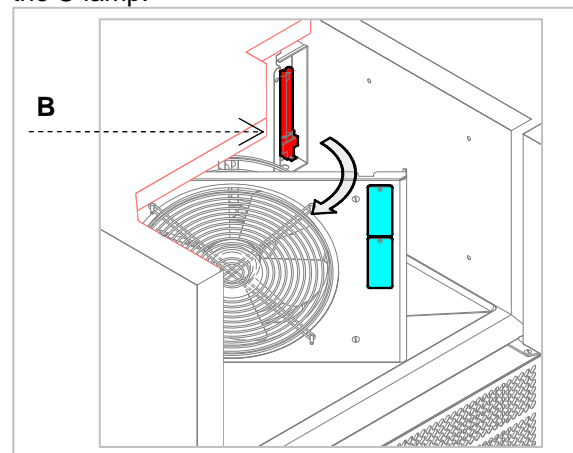



by sliding it upwards (B). Carry out all the operations in reverse order after having removed the U lamp.







## 7. TROUBLESHOOTING



The information shown below aims to help with the identification and correction of any anomalies and malfunctions which could occur during use. Some of these problems can be resolved by the

user. For the others, precise skill is required and they must therefore only be carried out by qualified staff.

Problem	Causes	Solutions
The refrigerator unit does not start	No voltage	Check the power supply cable.
		Check fuses.
		Check the correct connection of the appliance.
	Other causes	 <b>If the problem persists, contact the after-sales centre.</b>
The refrigerator unit functions continuously, cooling insufficiently	Room too hot	Air the environment
	Dirty condenser	clean the condenser
	Insufficient door sealing	check the gaskets
	Insufficient quantity of refrigerant gas	 <b>Contact the after-sales centre.</b>
	Condenser fan at a standstill	 <b>Contact the after-sales centre.</b>
The refrigerator unit does not stop	Probe faulty	 <b>Contact the after-sales centre.</b>
	Circuit board fault	 <b>Contact the after-sales centre.</b>
Presence of ice inside the evaporator		Carry out a defrosting cycle possibly with the door open.
		 <b>If the problem persists, contact the after-sales centre.</b>
Appliance noise	Persistent vibrations	check there is no contact between the appliance and other objects inside or outside

## 7.1. Faults Display

Code	Causes	Solutions
RTC	<p><b>Clock Error</b></p> <p>The device will not store date and time when the HACCP alarm appears</p>	Set the current date and time
CABINET PROBE	<p><b>Probe Error</b></p> <p>The type of probe is incorrect. The probe is defect. The probe - electronic card connection is incorrect. The temperature detected by the probe is beyond the limits allowed by the cell probe in use.</p>	<p> <b>Contact the after-sales service.</b></p> <ul style="list-style-type: none"> <li>➤ Make sure the probe is of kind PTC.</li> <li>➤ Verify the integrity of the cell probe.</li> <li>➤ Verify the accuracy of the connection instrument - probe.</li> </ul> <p>Check that the temperature near the cell probe is not beyond the established limits</p>
EVAPORATOR PROBE		
CONDENSER PROBE		
NEEDLE SENSOR1		
THERMAL SWITCH	<p><b>Evaporator Baffle Error</b></p> <p>The evaporator fan baffle has been opened.</p>	<p> <b>Contact the after-sales service.</b></p> <p>Close the evaporator fan baffle.</p> <p> <b>Contact the after-sales service.</b></p> <ul style="list-style-type: none"> <li>➤ Air the room.</li> <li>➤ Clean the condenser.</li> </ul> <p>Check that the fans are working properly.</p>
DOOR OPEN	<p><b>Door Open</b></p> <p>The door is open. If the alarm persists, verify the door micro switch alignment</p>	
HIGH TEMPERATURE	<p><b>HACCP temperature alarm.</b></p> <p>The temperature measured by the room probe has exceeded the limit imposed by its parameters.</p>	<ul style="list-style-type: none"> <li>➤ Verify the cell temperature</li> </ul>
LOW TEMPERATURE		
CYCLE DURATION	<p><b>Duration of Blast Chilling</b></p> <p>The blast chilling / freezing cycle ended beyond the maximum duration allowed (HCCP alarm)</p>	Check the product quantity inside the blast chiller.
BOARDS COMMUNICATIONS	<p><b>Interface communication error user- control module.</b></p>	<p> <b>Contact the after-sales service.</b></p>
BOARD COMPATIBILITY	<p><b>Interface compatibility error user- control module.</b></p>	<p> <b>Contact the after-sales service.</b></p>

Code	Causes	Solutions
NEEDLE PROBE	Core probe alarm (all enabled core probe sensors are in alarm)	 <b>Contact the after-sales service.</b>
POWER FAILURE	Power failure alarm (HACCP alarm).	Verify the connection device - electrical power supply
NEEDLE PRB INS FISH SAN.	Product probe insertion alarm during the fish sanitizing cycle.	Verify the proper insertion of the core probe
SANITIZATION DURATION	The fish sanitizing cycle has concluded beyond the maximum duration allowed (HCCP alarm)	Verify the proper insertion of the core probe
CONDENSER OVERHEAT	The temperature of the condenser has exceeded the first limit imposed. <ul style="list-style-type: none"> <li>• The condenser fan will be turned on</li> <li>• The alarm output will be activated.</li> </ul>	 <b>Contact the after-sales service.</b> <ul style="list-style-type: none"> <li>➤ Air the room.</li> <li>➤ Clean the condenser.</li> <li>➤ Check that the fans are working properly.</li> </ul>
COMPRESSOR BLOCKED	The temperature of the condenser has exceeded the second limit imposed. <ul style="list-style-type: none"> <li>• It will not be allowed either select or start any operating cycle.</li> <li>• If the error occurs during an operating cycle, the cycle will be interrupted</li> <li>• The alarm output will be activated.</li> </ul>	
NEEDLE PROBE INS.	Product probe insertion alarm during a blast chilling / freezing cycle.	Verify the proper insertion of the core probe

## 8. INSTALLATION

### 8.1. Packaging And Unpacking

Handle and install the appliance respecting the information provided by the manufacturer, shown directly on the packaging, on the appliance and in this manual.

The lifting and transportation system of the packaged product envisions the use of a fork-lift truck or a pallet stacker. When using these, particular attention must be paid to balancing the weight in order to prevent the risk of overturning (avoid excessive tilting!).



**ATTENTION:** When inserting the lifting device, pay attention to the power supply cable and the position of the feet.

The packaging is made of cardboard and the pallet of wood. A series of symbols is printed on the cardboard packaging which highlights, in accordance with international standards, the provisions to which the appliances are subjected during loading, unloading, transport and storage.



On delivery, check that the packaging is intact and has not undergone any damage during transportation.

The transportation company must be notified of any damage immediately.

The appliance must be unpacked as soon as possible to check that it is intact and undamaged.

Do not cut the cardboard with sharp tools so as not to damage to the steel panels underneath.

Pull the cardboard packaging upwards.

After having unpacked the appliance, check that the features correspond to those requested in the order;

Contact the dealer immediately if there are any anomalies.



**Packaging elements** (nylon bags, polystyrene foam, staples ...) must not be left within reach of children.

Remove the protective PVC film from the internal and external walls, avoiding the use of metal tools.

### 8.2. Installation

All the installation phases must be considered, from the moment of creation of the general plan.

The installation area must be equipped with all power supply and production residue drainage connections and must be suitably lit and respect current laws regarding hygiene and sanitary requirements.



The performance of the appliance is guaranteed with a room temperature of 32°C. A higher temperature can compromise its performance and, in more serious cases, cause the appliance's protections to start up. Therefore, consider the most critical room conditions that can be reached in that position before making a choice.

Level the appliance by acting on the individual feet.



This appliance can only be installed and operate in rooms which are permanently ventilated, in order to guarantee correct operation.



Connect and leave for a certain period of time (at least 2 hours) before checking functioning. During transport it is probable that the compressor lubricant oil has entered the refrigerant circuit blocking the capillary: as a consequence the appliance will function for a certain period of time without producing cold until the oil has returned to the compressor.



**⚠ ATTENTION:** the appliance requires the minimum functioning spaces, as shown in the attachments.

The defrosting water and the water that forms at the bottom of the refrigerating compartment during operation or during periodical internal

cleaning must be drained through a prearranged hose with a minimum diameter 3/4" connected to the hose at the bottom of the chiller.

A drain trap should also be guaranteed. The drain must be in compliance with Standards in force.

### 8.3. Electric Power Supply Connection

Connection must be carried out by authorised and qualified staff, respecting the current laws regarding the subject and using appropriate prescribed material.

**i** Before connecting the appliance to the electric mains, check that the voltage and the frequency correspond to the data stated on the registration plate applied on the rear of the appliance.

**i** The appliance is supplied with an operating voltage of 230V~ 50 or 220V 60Hz.

**⚠** Before connection, ensure the presence of a relevant differential switch with adequate power in the mains power supply, upstream from the appliance, in order to protect the appliance from overloads or short circuits

### 8.4. Condensing unit water connection

The chiller cabinets with water condensation have been designed to use normal tap water.

Connect the mains pipe to the appliance connection pipe, positioning a shut-off cock **(A)** to interrupt the water supply when necessary. Install some easily reachable filters downstream from this.

**i** The water pressure must be between 150÷300 kPA (1.5÷3 bar).

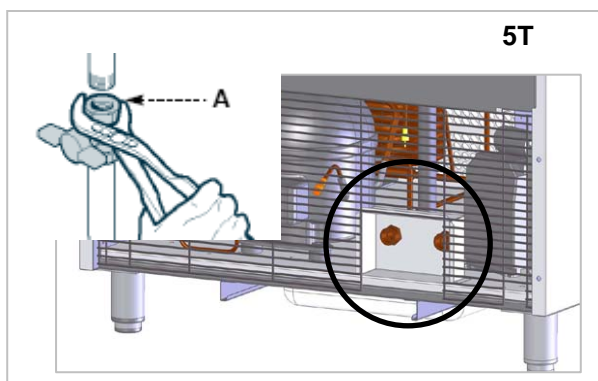
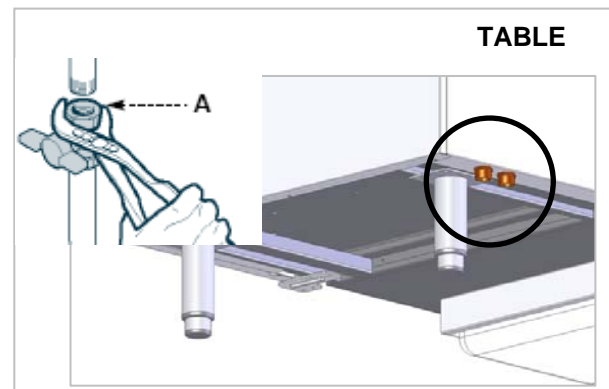

**⚠** Attachment to the water network must be carried out before switching the appliance on: if cooling is missing from the condensing circuit, the maximum pressure switch intervenes, which blocks the machine.

The machine must also be checked for leaks that could interfere with electrical parts and cause short-circuits.

It is preferable for both the water drain and supply pipes to be fitted with cocks to stop the water supply to the machine during maintenance.

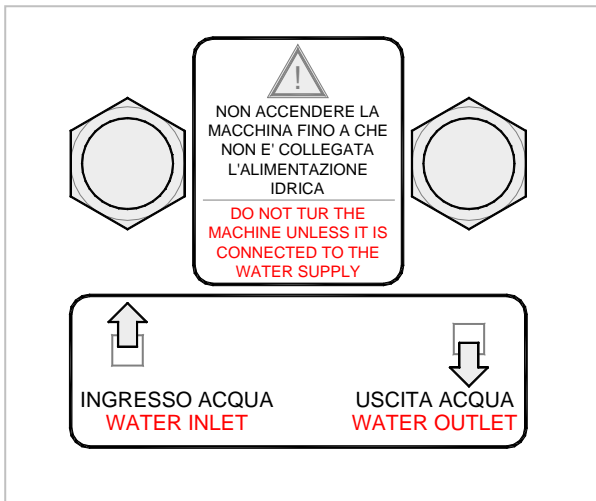

Both water inlet and drain pipe connections are 3/4". To know which attachment to use (both 3/4"), simply follow the indications in the figure (the same label should be found near the water supply connections).

**i** If the water has a high mineral salt content (i.e. if it is too hard), to ensure long and efficient

## 8.5. Inspection

The appliance is delivered in conditions such that it can be started-up by the user.

This functionality is guaranteed by passing the tests (electric inspection - functional inspection, appearance inspection) and relative certification through the specific attachments.

At least the following should be checked after installation:

- Check the electric connections.

life to the exchanger we suggest you install a water softener at the water inlet.

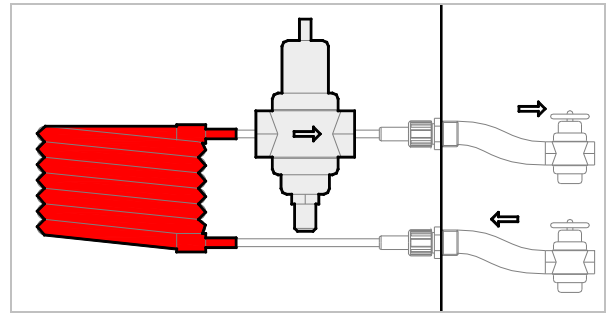

Even if the pressure valve has been calibrated before leaving the factory, after having connected the machine to the water supply and turned on the any cocks installed, check for water leaks from the drain when the machine is at a standstill. In case of a leak, adjust the pressure valve until the leak stops.

## 9. DISPOSAL OF THE APPLIANCE

 This appliance is marked in compliance with the 2002/96/EC European Directive, WASTE ELECTRICAL AND ELECTRONIC EQUIPMENT (WEEE).

 By assuring that this product is disposed of correctly, the user contributes to preventing the potential negative consequences on the environment and health.



The  symbol found on the product or on the accompanying documentation indicates

that this product must not be treated as domestic waste but must be taken to suitable collection points for the recycling of electric and electronic appliances.

Dispose of it following local regulations regarding waste disposal.

For further information regarding the treatment, recovery and recycling of this product, contact the relevant local office, the domestic waste collection service or the shop where the product was purchased.

## 10. REFRIGERANT TECHNICAL CARD

The refrigerant used in the machine is **R452A** fluid. Below find the components of the fluid:

- HFC-125 59%
- HFC-1234yf 30%
- HFC-32 11%

### IDENTIFICATION OF DANGERS

The rapid evaporation of the liquid can cause freezing. The inhalation of high concentrations of vapour can cause irregular heartbeat, short term narcotic effects (including vertigo, headache and mental confusion), fainting and death.

- Effects to the eyes: Freezing or cold burns caused by contact with the liquid.
- Effects on the skin: Freezing or cold burns caused by contact with the liquid.
- Effects of ingestion. Ingestion is not considered a means of exposure

### FIRST AID

**Eyes:** In the case of contact, wash the eye well using a large amount of water for at least 15 minutes. Consult a doctor.

**Effects on the skin:** Wash with water for at least 15 minutes after excessive contact. If necessary, cure freezing by gently warming the area in question. Consult a doctor in the case of irritation.

**Ingestion:** Ingestion is not considered a means of exposure.

**Inhalation:** If large concentrations are inhaled, go into the open air. Keep the person calm. If the person cannot breathe, perform artificial respiration. If respiration is difficult, apply oxygen. Consult a doctor.

retigo<sup>®</sup>

PERFECTION IN COOKING AND MORE...

**RETIGO s.r.o.**

Láň 2310

756 61 Rožnov pod Radhoštěm

Email: [info@retigo.cz](mailto:info@retigo.cz)

Tel.: +420 571 665 511

[www.retigo.com](http://www.retigo.com)